

# NCP1550

## 600 kHz PWM/PFM Step-Down DC-DC Controller

The NCP1550 is a monolithic micropower high frequency voltage mode step-down controller IC, specially designed for battery operated hand-held electronic products. With appropriate external P-type MOSFET, the device can provide up to 2.0 A loading current with high conversion efficiency. The device operates in Constant-Frequency PWM mode at normal operation, that ensures low output ripple noise, and which will automatically switch to PFM mode at low output loads for higher efficiency. Additionally, value-added features of Chip Enable to reduce IC Off-State current and integrated feedback resistor network, make it the best choice for portable applications. The device is designed to operate for voltage regulation with minimum external components and board space. This device is available in a TSOP-5 package with six standard output voltage options.

### Features

- High Efficiency 92%, Typical
- Low Quiescent Bias Current of 50  $\mu$ A  
(Typical at PFM Mode with No Load)
- Output Voltage Options from 1.8 V to 3.3 V  
with High Accuracy  $\pm$  2.0%
- Low Output Voltage Ripple, 50 mV, Typical
- PWM Switching Frequency at 600 kHz
- Automatic PWM/PFM Switchover at Light Load Condition
- Very Low Dropout Operation, 100% Max. Duty Cycle
- Chip Enable Pin with On-Chip 150 nA Pullup Current Source
- Low Shutdown Current, 0.3  $\mu$ A, Typical
- Input Voltage Range from 2.45 V to 5.5 V
- Built-in Soft-Start
- Internal Undervoltage Lockout (UVLO) Protection
- Low Profile and Minimum External Components
- Micro Miniature TSOP-5 Package
- Pb-Free Packages are Available

### Typical Applications

- Personal Digital Assistant (PDA)
- Camcorders and Digital Still Camera
- Hand-Held Instrument
- Distributed Power System
- Computer Peripheral
- Conversion from Four NiMH or NiCd or One Lithium-ion Cells to 3.3 V/1.8 V



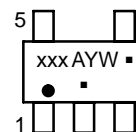
ON Semiconductor®

<http://onsemi.com>



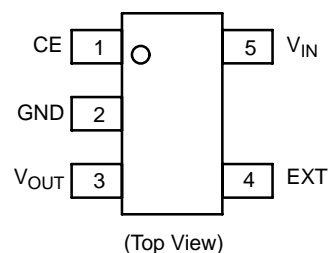
TSOP-5  
SN SUFFIX  
CASE 483

### MARKING DIAGRAM



xxx = Specific Device Code  
A = Assembly Location  
Y = Year  
W = Work Week  
▪ = Pb-Free Package  
(Note: Microdot may be in either location)

### PIN CONNECTIONS



### ORDERING INFORMATION

See detailed ordering and shipping information in the package dimensions section on page 16 of this data sheet.

# NCP1550

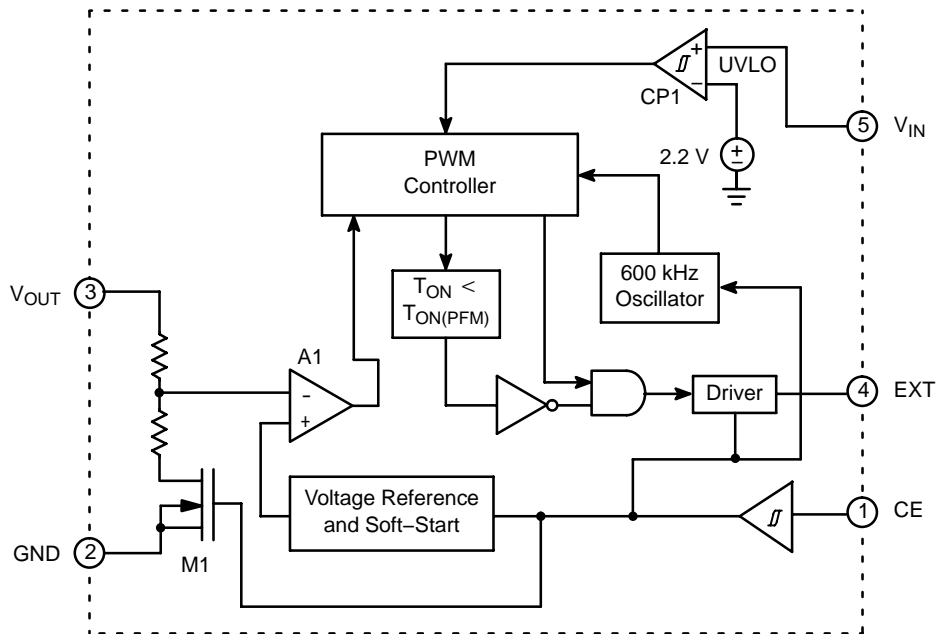


Figure 1. Simplified Block Diagram

## PIN FUNCTION DESCRIPTIONS

Pin	Symbol	Description
1	CE	Chip Enable pin, active high (internal pullup current source). By connecting this pin to GND, the switching operation of the controller will be stopped.
2	GND	Ground Connection
3	V <sub>OUT</sub>	Output voltage monitoring input. This pin must be connected to the regulated output node as a feedback to on-chip control circuitry. V <sub>OUT</sub> is internally connected to the on-chip voltage divider that determines the output voltage level.
4	EXT	Gate drive for external P-MOSFET
5	V <sub>IN</sub>	Power supply input

## MAXIMUM RATINGS (T<sub>A</sub> = 25°C unless otherwise noted)

Rating	Symbol	Value	Unit
Device Power Supply, V <sub>IN</sub> (Pin 5)	V <sub>IN</sub>	-0.3 to 6.0	V
Input/Output Pins CE (Pin 1) V <sub>OUT</sub> (Pin 3) EXT (Pin 4)	V <sub>CE</sub> V <sub>OUT</sub> V <sub>EXT</sub>	-0.3 to 6.0 -0.3 to 6.0 -0.3 to 6.0	V
Thermal Characteristics TSOP-5 Plastic Package, Case 483-01 Thermal Resistance, Junction-to-Air	R <sub>θJA</sub>	250	°C/W
Operating Junction Temperature Range	T <sub>J</sub>	-40 to +150	°C
Operating Ambient Temperature Range	T <sub>A</sub>	-40 to +85	°C
Storage Temperature Range	T <sub>stg</sub>	-55 to +150	°C

Stresses exceeding Maximum Ratings may damage the device. Maximum Ratings are stress ratings only. Functional operation above the Recommended Operating Conditions is not implied. Extended exposure to stresses above the Recommended Operating Conditions may affect device reliability.

NOTE: ESD data available upon request.

- This device series contains ESD protection and exceeds the following tests:  
Human Body Model (HBM) ±2.0 kV per JEDEC standard: JESD22-A114.  
Machine Model (MM) ±200V per JEDEC standard: JESD22-A115.
- Latchup Current Maximum Rating: 150 mA per JEDEC standard: JESD78.
- Moisture Sensitivity Level (MSL): 1 per IPC/JEDEC standard: J-STD-020A.

# NCP1550

**ELECTRICAL CHARACTERISTICS** ( $V_{IN} = 5.0\text{ V}$ ,  $T_A = 25^\circ\text{C}$  for typical value,  $-40^\circ\text{C} \leq T_A \leq 85^\circ\text{C}$  for min/max values unless otherwise noted.)

Characteristic	Symbol	Min	Typ	Max	Unit
<b>TOTAL DEVICE</b>					
Input Voltage	$V_{IN}$	2.45	–	5.50	V
Output Voltage ( $I_{LOAD} = 0\text{ mA}$ , $T_A = 25^\circ\text{C}$ )	$V_{OUT}$				V
NCP1550SN18T1		1.764	1.8	1.836	
NCP1550SN19T1		1.862	1.9	1.938	
NCP1550SN25T1		2.450	2.5	2.550	
NCP1550SN27T1		2.646	2.7	2.754	
NCP1550SN30T1		2.940	3.0	3.060	
NCP1550SN33T1		3.234	3.3	3.366	
Input Current into $V_{OUT}$ Pin	$I_{VOUT}$				$\mu\text{A}$
NCP1550SN18T1		–	2.5	4.0	
NCP1550SN19T1		–	2.5	4.0	
NCP1550SN25T1		–	2.5	4.0	
NCP1550SN27T1		–	2.5	4.0	
NCP1550SN30T1		–	2.5	4.0	
NCP1550SN33T1		–	2.5	4.0	
Temperature Coefficient	$\Delta V_{OUT}/\Delta V_T$	–	100	–	ppm/ $^\circ\text{C}$
Operating Current ( $V_{IN} = 5.0\text{ V}$ , $V_{CE} = 5.0\text{ V}$ , No External Components)	$I_{DD}$				$\mu\text{A}$
NCP1550SN18T1		–	50	80	
NCP1550SN19T1		–	50	80	
NCP1550SN25T1		–	50	80	
NCP1550SN27T1		–	50	80	
NCP1550SN30T1		–	50	80	
NCP1550SN33T1		–	50	80	
Off-State Current ( $V_{IN} = 5.0\text{ V}$ , $V_{CE} = 0\text{ V}$ , $T_A = 25^\circ\text{C}$ )	$I_{OFF}$				$\mu\text{A}$
NCP1550SN18T1		–	0.3	0.5	
NCP1550SN19T1		–	0.3	0.5	
NCP1550SN25T1		–	0.3	0.5	
NCP1550SN27T1		–	0.3	0.5	
NCP1550SN30T1		–	0.3	0.5	
NCP1550SN33T1		–	0.3	0.5	

## OSCILLATOR

Frequency	$F_{OSC}$	510	600	690	kHz
Frequency Temperature Coefficient ( $T_A = -40^\circ\text{C}$ to $85^\circ\text{C}$ )	$\Delta F_{OSC}/\Delta T_A$	–	0.11	–	%/ $^\circ\text{C}$
Maximum Duty Cycle	$D_{MAX}$	100	–	–	%
PWM/PFM Switchover ON Time Threshold (Note 4)	$T_{ON(PFM)}$	167	320	500	ns
Soft-Start Delay Time (Note 4)	$T_{SS}$	–	8.0	–	ms
Protection Delay Time (Auto Restart)	$T_{prot}$	–	8.0	–	ms

## OUTPUT DRIVE (PIN 4)

EXT “H” Output Current ( $V_{EXT} = V_{IN} - 0.4\text{ V}$ )	$I_{EXTH}$	–	–60	–	mA
EXT “L” Output Current ( $V_{EXT} = 0.4\text{ V}$ )	$I_{EXTL}$	–	100	–	mA
EXT “L–H” Rise Time ( $C_{LOAD} = 1000\text{ pF}$ ) ( $V_{IN} = 5.0\text{ V}$ )	$T_r$	–	65	–	ns
EXT “H–L” Fall Time ( $C_{LOAD} = 1000\text{ pF}$ ) ( $V_{IN} = 5.0\text{ V}$ )	$T_f$	–	40	–	ns
EXT “L–H” Rise Time ( $C_{LOAD} = 5.0\text{ nF}$ ) ( $V_{IN} = 5.0\text{ V}$ )	$T_r$	–	140	–	ns
EXT “H–L” Fall Time ( $C_{LOAD} = 5.0\text{ nF}$ ) ( $V_{IN} = 5.0\text{ V}$ )	$T_f$	–	90	–	ns

4. PWM/PFM Switchover ON Time Threshold min/max guaranteed by design only.

# NCP1550

**ELECTRICAL CHARACTERISTICS (continued)** ( $V_{IN} = 5.0\text{ V}$ ,  $T_A = 25^\circ\text{C}$  for typical value,  $-40^\circ\text{C} \leq T_A \leq 85^\circ\text{C}$  for min/max values unless otherwise noted.)

Characteristic	Symbol	Min	Typ	Max	Unit
<b>CE (PIN 1)</b>					
CE "H" Input Voltage	$V_{CEH}$	1.3	–	–	V
CE "L" Input Voltage	$V_{CEL}$	–	–	0.3	V
CE "H" Input Current ( $V_{IN} = V_{CE} = 5.0\text{ V}$ )	$I_{CEH}$	–0.5	0	0.5	$\mu\text{A}$
CE "L" Input Current ( $V_{IN} = 5.0$ , $V_{CE} = 0\text{ V}$ )	$I_{CEL}$	–0.5	0.15	0.5	$\mu\text{A}$
<b>Undervoltage Lockout</b>					
Undervoltage Lockout Threshold	$V_{UVLO}$	1.60	2.20	2.40	V
Undervoltage Lockout Hysteresis	$V_{UVLO\_HYS}$	–	50	–	mV

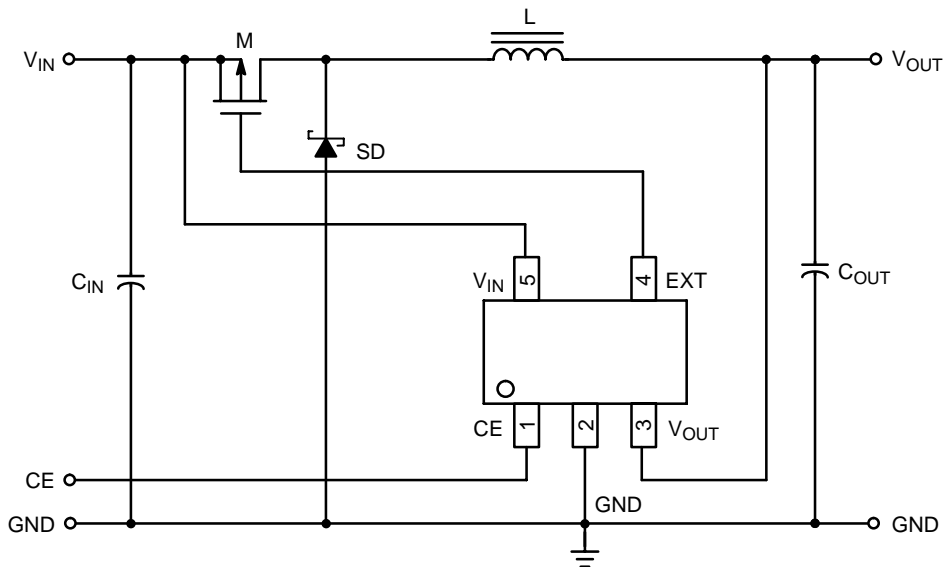


Figure 2. Typical Application Diagram

# NCP1550

## TYPICAL OPERATING CHARACTERISTICS

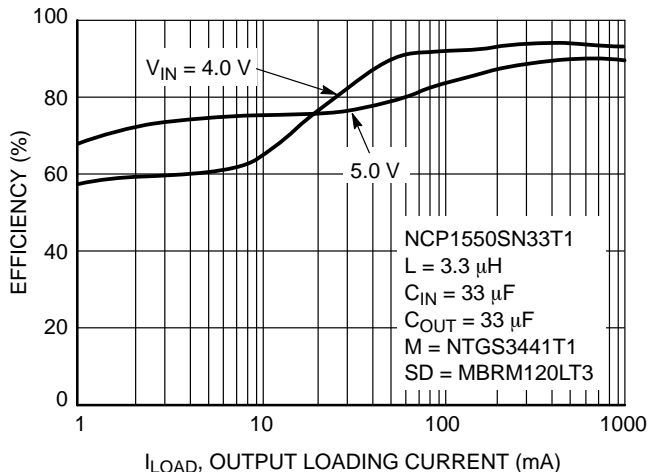


Figure 3. Efficiency versus Load Current

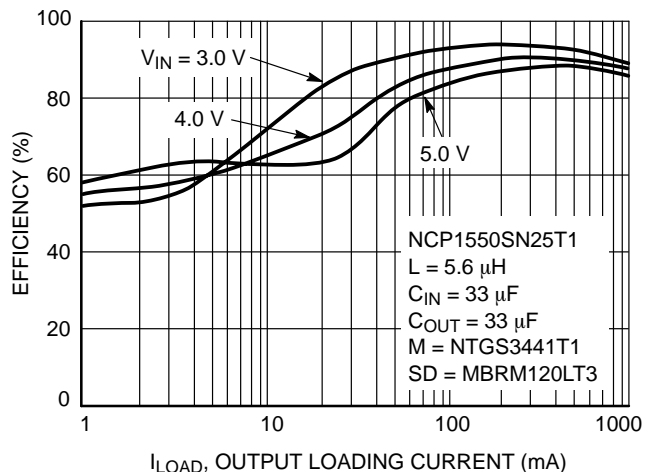


Figure 4. Efficiency versus Load Current

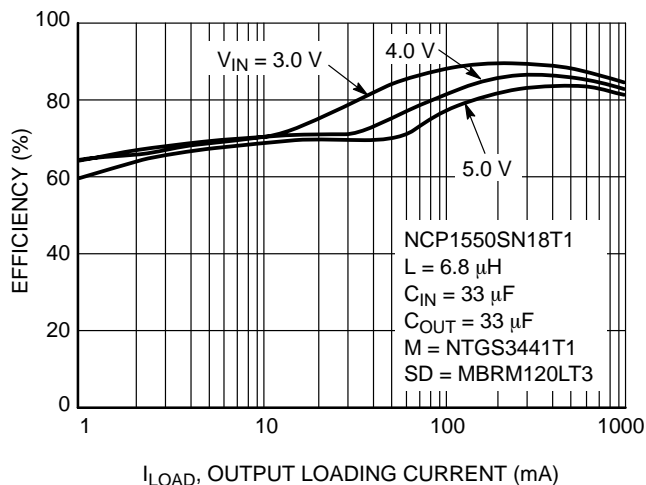
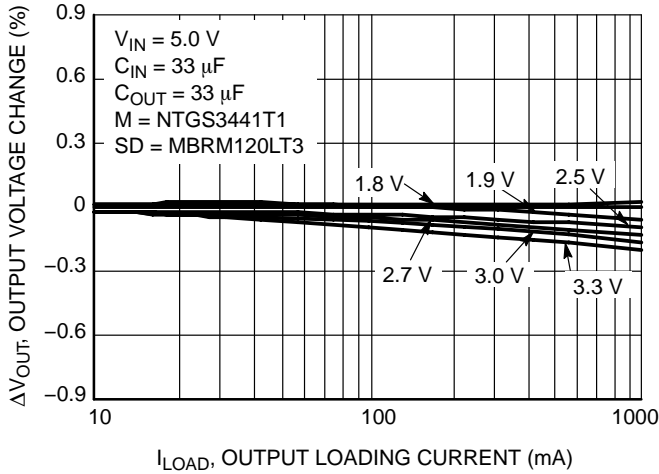


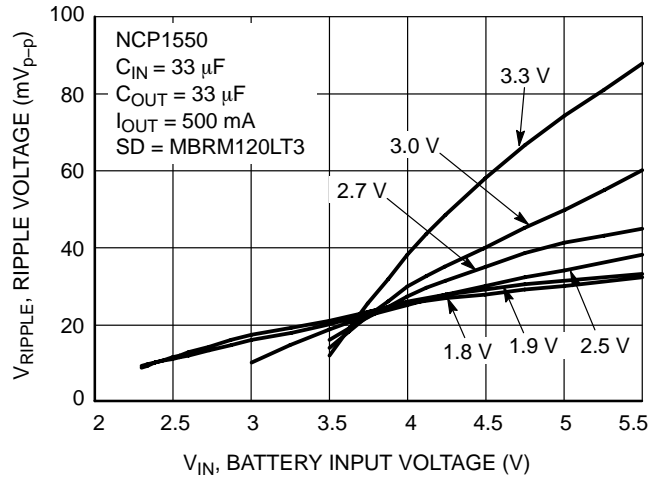
Figure 5. Efficiency versus Load Current

# NCP1550

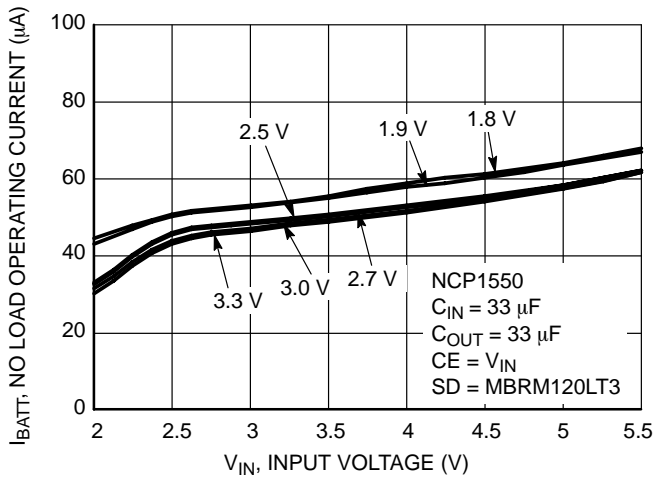
## TYPICAL OPERATING CHARACTERISTICS



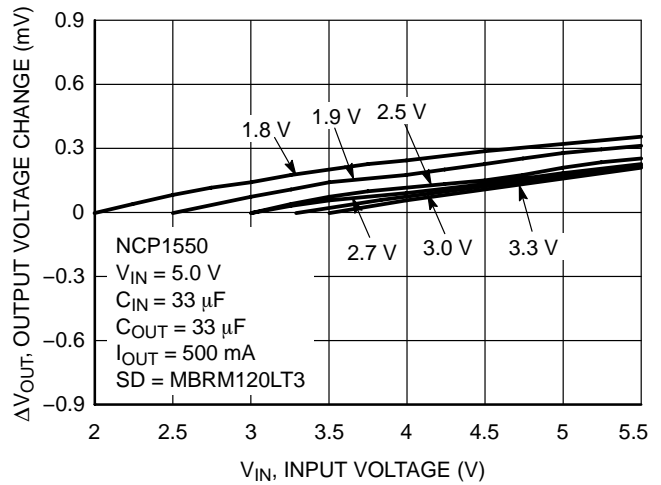
**Figure 6. Output Voltage Change versus Load Current**



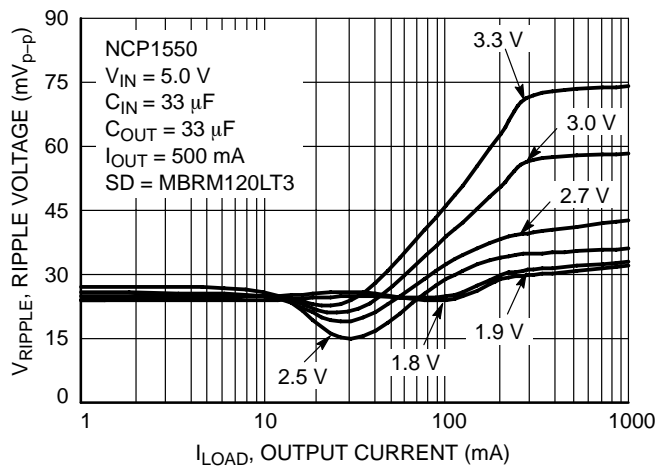
**Figure 7. Output Ripple Voltage versus Input Voltage**



**Figure 8. No Load Operating Current versus Input Voltage**

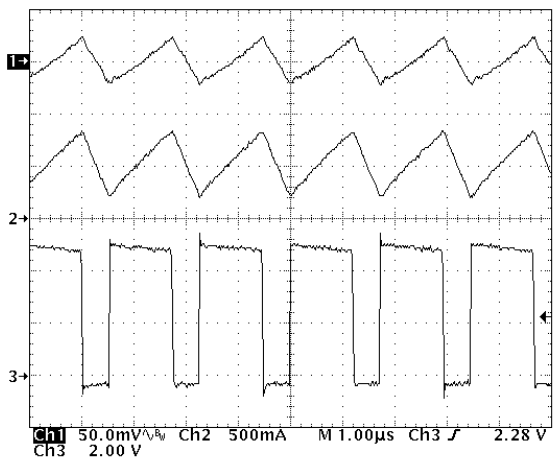


**Figure 9. Output Voltage Change versus Input Voltage**



**Figure 10. Output Ripple Voltage versus Output Current**

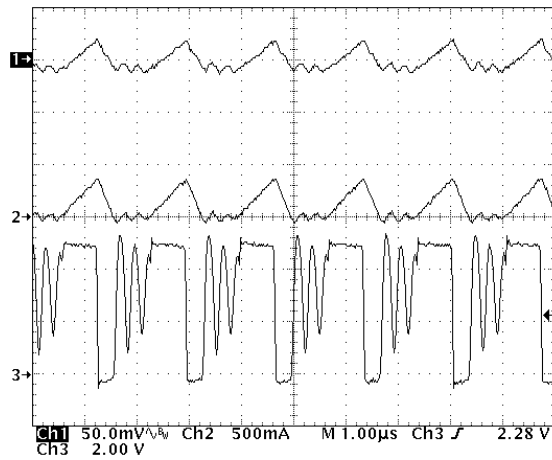
# NCP1550



( $V_{IN} = 5.0 \text{ V}$ ,  $I_{LOAD} = 500 \text{ mA}$ ,  $L = 3.3 \mu\text{H}$ ,  $C_{OUT} = 100 \mu\text{F}$ )

Upper Trace: Output Voltage Ripple, 50 mV/Division  
 Middle Trace: Inductor Current,  $I_L$ , 500 mA/Division  
 Lower Trace: Voltage at Cathode of Schottky Diode, 2.0 V/Division

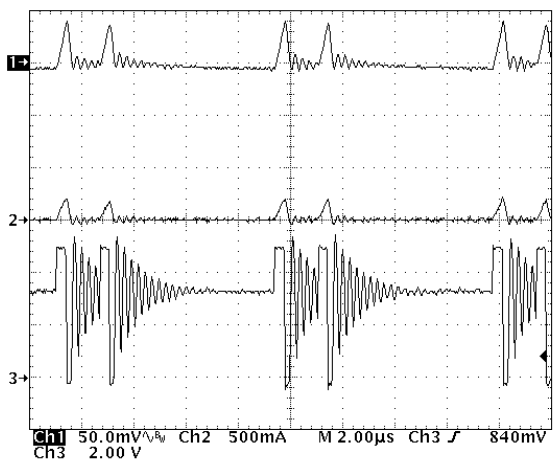
**Figure 11. Continuous Conduction Mode PWM Switching Waveform for  $V_{OUT} = 3.3 \text{ V}$**



( $V_{IN} = 5.0 \text{ V}$ ,  $I_{LOAD} = 100 \text{ mA}$ ,  $L = 3.3 \mu\text{H}$ ,  $C_{OUT} = 100 \mu\text{F}$ )

Upper Trace: Output Voltage Ripple, 50 mV/Division  
 Middle Trace: Inductor Current,  $I_L$ , 500 mA/Division  
 Lower Trace: Voltage at Cathode of Schottky Diode, 2.0 V/Division

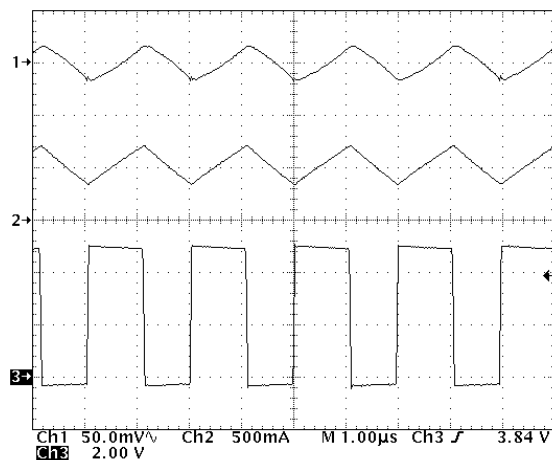
**Figure 12. Discontinuous Conduction Mode PWM Switching Waveform for  $V_{OUT} = 3.3 \text{ V}$**



( $V_{IN} = 5.0 \text{ V}$ ,  $I_{LOAD} = 10 \text{ mA}$ ,  $L = 3.3 \mu\text{H}$ ,  $C_{OUT} = 100 \mu\text{F}$ )

Upper Trace: Output Voltage Ripple, 50 mV/Division  
 Middle Trace: Inductor Current,  $I_L$ , 500 mA/Division  
 Lower Trace: Voltage at Cathode of Schottky Diode, 2.0 V/Division

**Figure 13. Discontinuous Conduction Mode PFM Switching Waveform for  $V_{OUT} = 3.3 \text{ V}$**

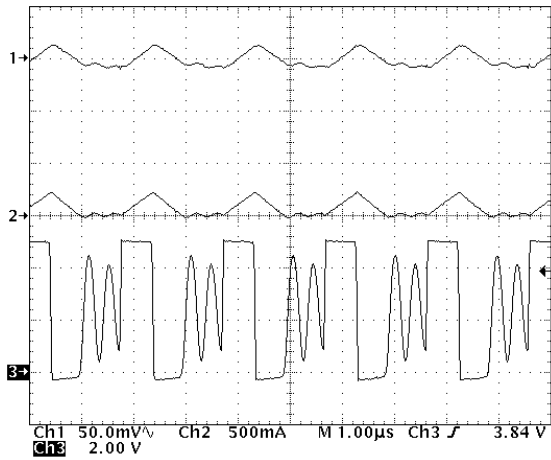


( $V_{IN} = 5.0 \text{ V}$ ,  $I_{LOAD} = 500 \text{ mA}$ ,  $L = 5.6 \mu\text{H}$ ,  $C_{OUT} = 33 \mu\text{F}$ )

Upper Trace: Output Voltage Ripple, 50 mV/Division  
 Middle Trace: Inductor Current,  $I_L$ , 500 mA/Division  
 Lower Trace: Voltage at Cathode of Schottky Diode, 2.0 V/Division

**Figure 14. Continuous Conduction Mode PWM Switching Waveform for  $V_{OUT} = 2.5 \text{ V}$**

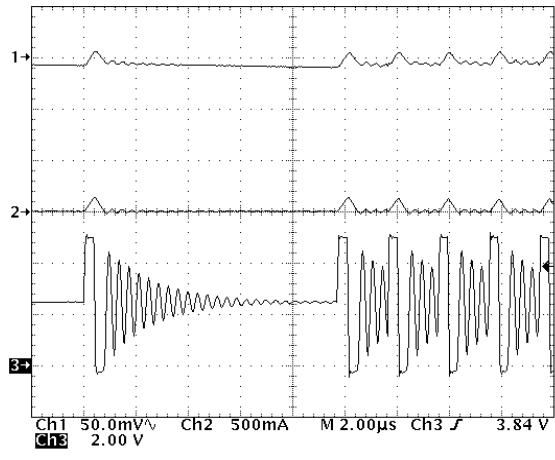
# NCP1550



( $V_{IN} = 5.0\text{ V}$ ,  $I_{LOAD} = 100\text{ mA}$ ,  $L = 5.6\text{ }\mu\text{H}$ ,  $C_{OUT} = 33\text{ }\mu\text{F}$ )

Upper Trace: Output Voltage Ripple, 50 mV/Division  
Middle Trace: Inductor Current,  $I_L$ , 500 mA/Division  
Lower Trace: Voltage at Cathode of Schottky Diode, 2.0 V/Division

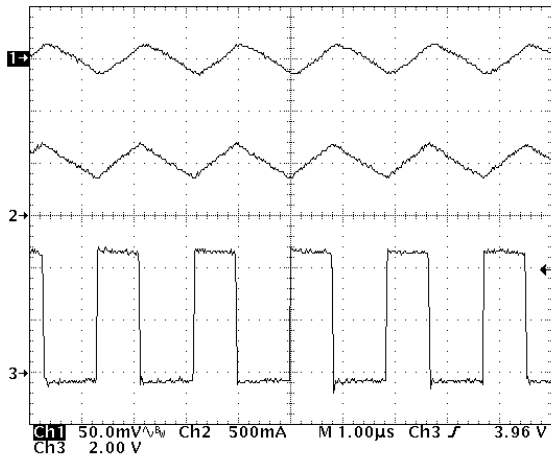
**Figure 15. Discontinuous Conduction Mode PWM Switching Waveform for  $V_{OUT} = 2.5\text{ V}$**



( $V_{IN} = 5.0\text{ V}$ ,  $I_{LOAD} = 30\text{ mA}$ ,  $L = 5.6\text{ }\mu\text{H}$ ,  $C_{OUT} = 33\text{ }\mu\text{F}$ )

Upper Trace: Output Voltage Ripple, 50 mV/Division  
Middle Trace: Inductor Current,  $I_L$ , 500 mA/Division  
Lower Trace: Voltage at Cathode of Schottky Diode, 2.0 V/Division

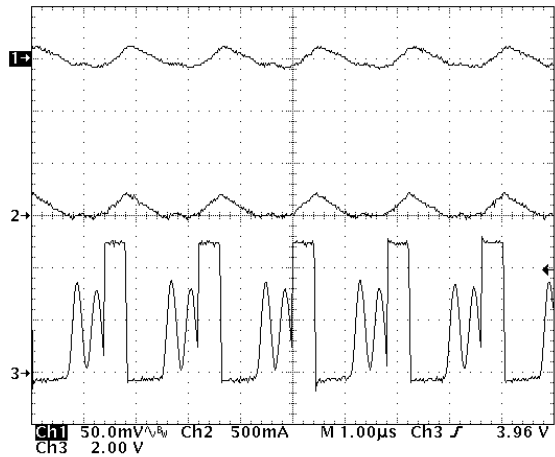
**Figure 16. Discontinuous Conduction Mode PFM Switching Waveform for  $V_{OUT} = 2.5\text{ V}$**



( $V_{IN} = 5.0\text{ V}$ ,  $I_{LOAD} = 500\text{ mA}$ ,  $L = 6.8\text{ }\mu\text{H}$ ,  $C_{OUT} = 33\text{ }\mu\text{F}$ )

Upper Trace: Output Voltage Ripple, 50 mV/Division  
Middle Trace: Inductor Current,  $I_L$ , 500 mA/Division  
Lower Trace: Voltage at Cathode of Schottky Diode, 2.0 V/Division

**Figure 17. Continuous Conduction Mode PWM Switching Waveform for  $V_{OUT} = 1.8\text{ V}$**



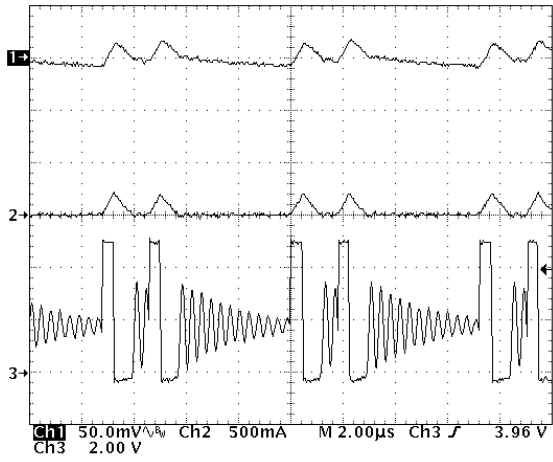
( $V_{IN} = 5.0\text{ V}$ ,  $I_{LOAD} = 60\text{ mA}$ ,  $L = 6.8\text{ }\mu\text{H}$ ,  $C_{OUT} = 33\text{ }\mu\text{F}$ )

Upper Trace: Output Voltage Ripple, 50 mV/Division  
Middle Trace: Inductor Current,  $I_L$ , 500 mA/Division  
Lower Trace: Voltage at Cathode of Schottky Diode, 2.0 V/Division

**Figure 18. Discontinuous Conduction Mode PWM Switching Waveform for  $V_{OUT} = 1.8\text{ V}$**



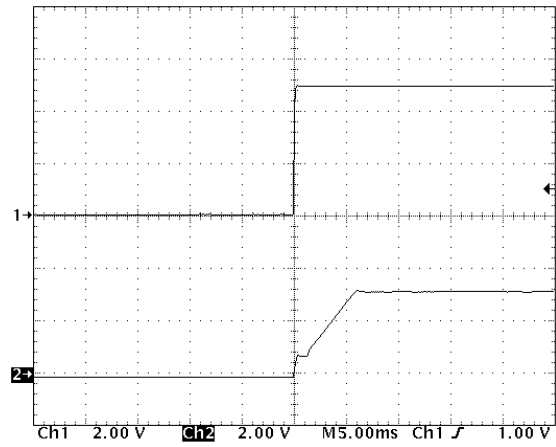
# NCP1550



( $V_{IN} = 5.0\text{ V}$ ,  $I_{LOAD} = 30\text{ mA}$ ,  $L = 6.8\text{ }\mu\text{H}$ ,  $C_{OUT} = 33\text{ }\mu\text{F}$ )

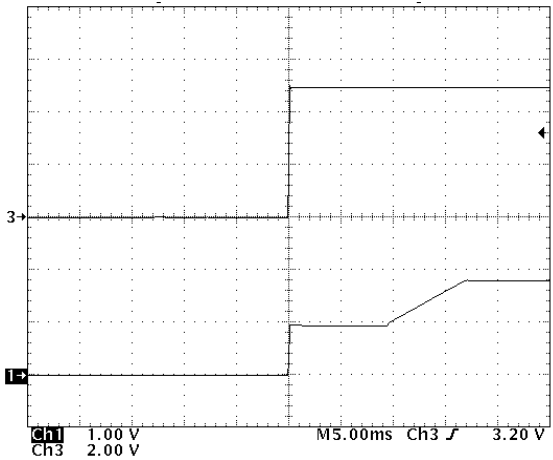
Upper Trace: Output Voltage Ripple, 50 mV/Division  
 Middle Trace: Inductor Current,  $I_L$ , 500 mA/Division  
 Lower Trace: Voltage at Cathode of Schottky Diode, 2.0 V/Division

**Figure 19. Discontinuous Conduction Mode PFM Switching Waveform for  $V_{OUT} = 1.8\text{ V}$**



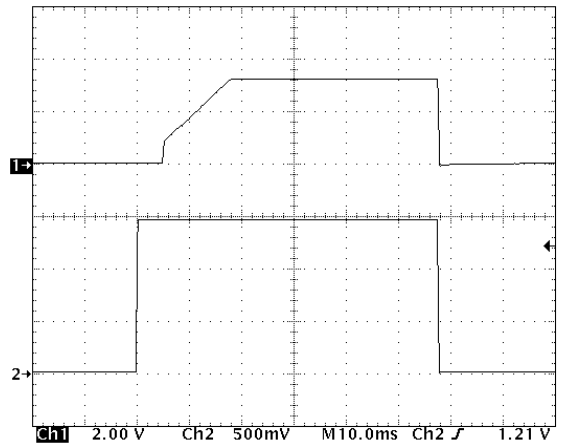
Upper Trace: Input Voltage, 2.0 V/Division  
 Lower Trace: Output Voltage, 2.0 V/Division

**Figure 20. Startup Transient Response for  $V_{OUT} = 3.3\text{ V}$**



Upper Trace: Input Voltage, 2.0 V/Division  
 Lower Trace: Output Voltage, 1.0 V/Division

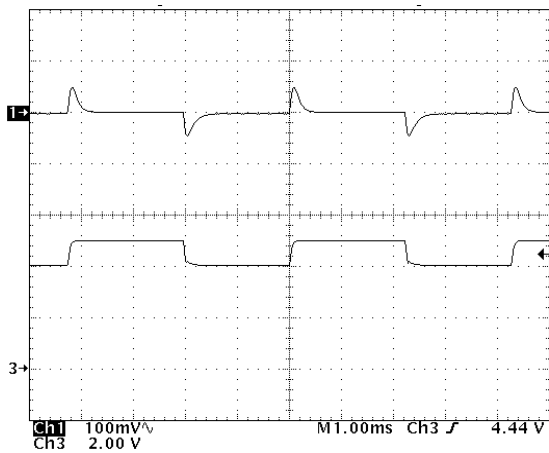
**Figure 21. Startup Transient Response for  $V_{OUT} = 1.8\text{ V}$**



Upper Trace: Output Voltage Waveform, 2.0 V/Division  
 Lower Trace: Chip Enable/Disable Pin Waveform, 0.5 V/Division

**Figure 22. Chip Enable/Disable Output Voltage Waveform**

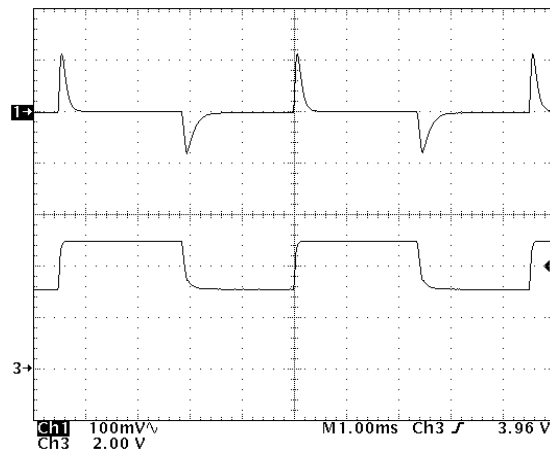
# NCP1550



( $V_{IN} = 4.0$  to  $5.0$  V,  $L = 3.3$   $\mu$ H,  $C_{OUT} = 33$   $\mu$ F,  $I_{LOAD} = 1.0$  A)

Upper Trace: Output Voltage Ripple, 100 mV/Division  
Lower Trace: Input Voltage, 2.0 V/Division

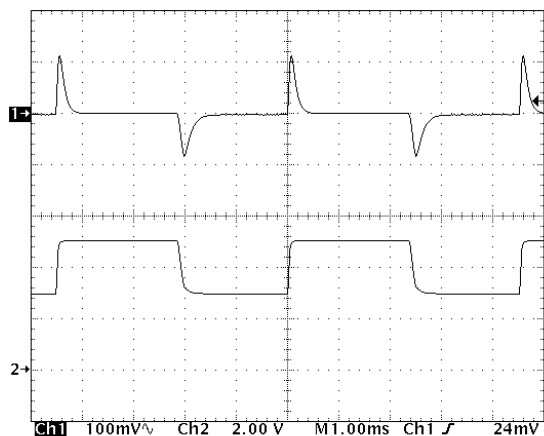
**Figure 23. Line Transient Response for  $V_{OUT} = 3.3$  V**



( $V_{IN} = 3.0$  to  $5.0$  V,  $L = 5.6$   $\mu$ H,  $C_{OUT} = 33$   $\mu$ F,  $I_{LOAD} = 1.0$  A)

Upper Trace: Output Voltage Ripple, 100 mV/Division  
Lower Trace: Input Voltage, 2.0 V/Division

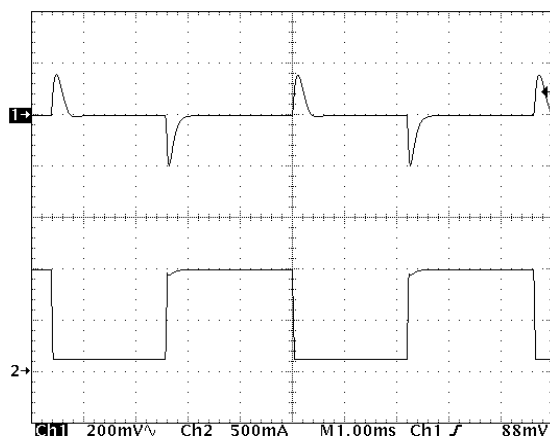
**Figure 24. Line Transient Response for  $V_{OUT} = 2.5$  V**



( $V_{IN} = 3.0$  to  $5.0$  V,  $L = 6.8$   $\mu$ H,  $C_{OUT} = 33$   $\mu$ F,  $I_{LOAD} = 1.0$  A)

Upper Trace: Output Voltage Ripple, 100 mV/Division  
Lower Trace: Input Voltage,  $V_{IN}$ , 2.0 V/Division

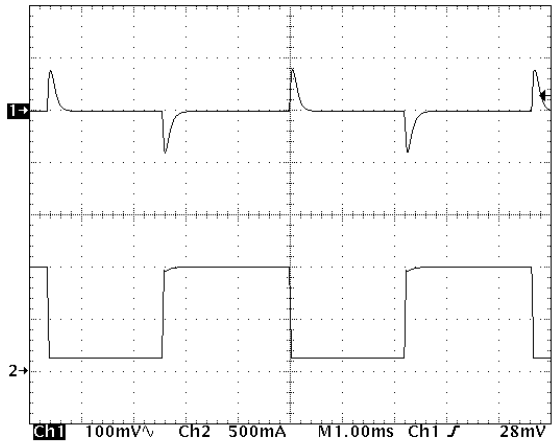
**Figure 25. Line Transient Response for  $V_{OUT} = 1.8$  V**



( $V_{IN} = 5.0$  V,  $I_{LOAD} = 100$  mA to  $1.0$  A,  $L = 3.3$   $\mu$ H,  $C_{OUT} = 33$   $\mu$ F)

Upper Trace: Output Voltage Ripple, 200 mV/Division  
Lower Trace: Load Current,  $I_{LOAD}$ , 500 mA/Division

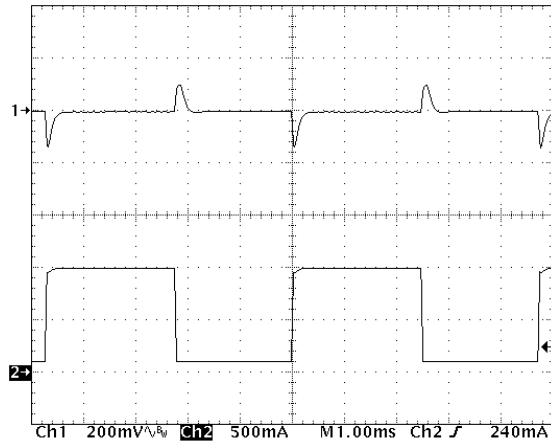
**Figure 26. Load Transient Response for  $V_{OUT} = 3.3$  V**



( $V_{IN} = 5.0\text{ V}$ ,  $I_{LOAD} = 100\text{ mA to }1.0\text{ A}$ ,  $L = 5.6\text{ }\mu\text{H}$ ,  $C_{OUT} = 33\text{ }\mu\text{F}$ )

Upper Trace: Output Voltage Ripple, 100 mV/Division  
Lower Trace: Load Current,  $I_{LOAD}$ , 500 mA/Division

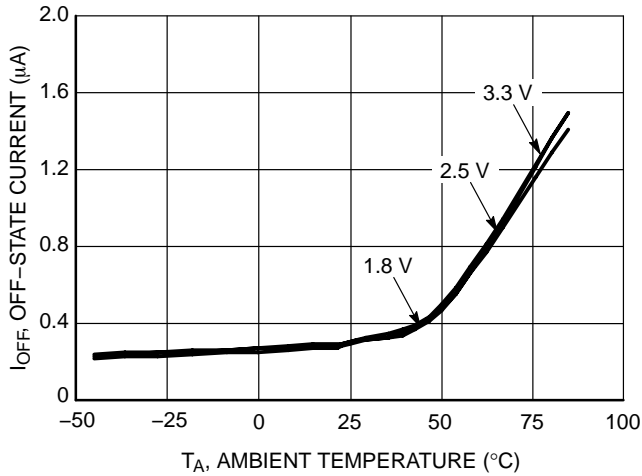
**Figure 27. Load Transient Response for  $V_{OUT} = 2.5\text{ V}$**



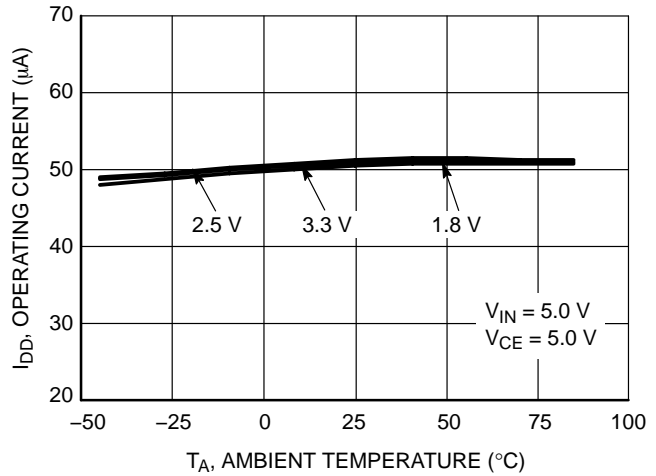
( $V_{IN} = 5.0\text{ V}$ ,  $I_{LOAD} = 100\text{ mA to }1.0\text{ A}$ ,  $L = 6.8\text{ }\mu\text{H}$ ,  $C_{OUT} = 33\text{ }\mu\text{F}$ )

Upper Trace: Output Voltage Ripple, 100 mV/Division  
Lower Trace: Load Current,  $I_{LOAD}$ , 500 mA/Division

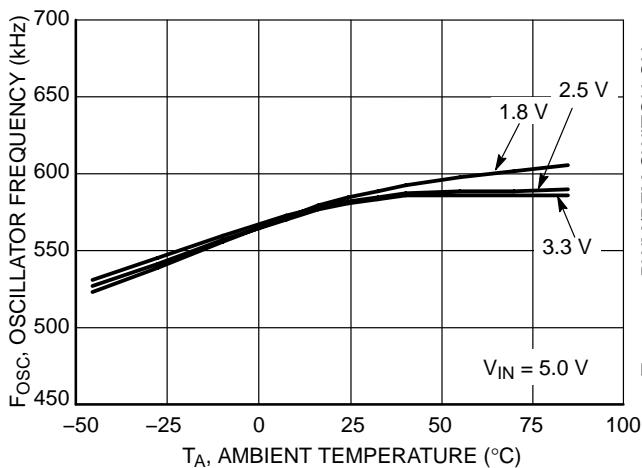
**Figure 28. Load Transient Response for  $V_{OUT} = 1.8\text{ V}$**



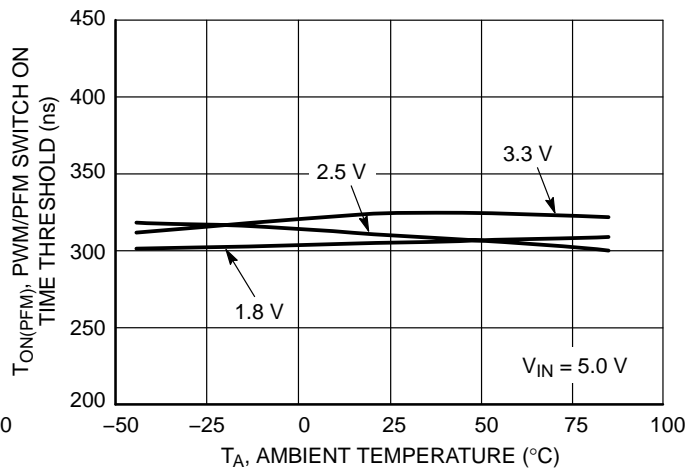
**Figure 29. Off-Stage Current versus Ambient Temperature**



**Figure 30. Operating Current versus Ambient Temperature**

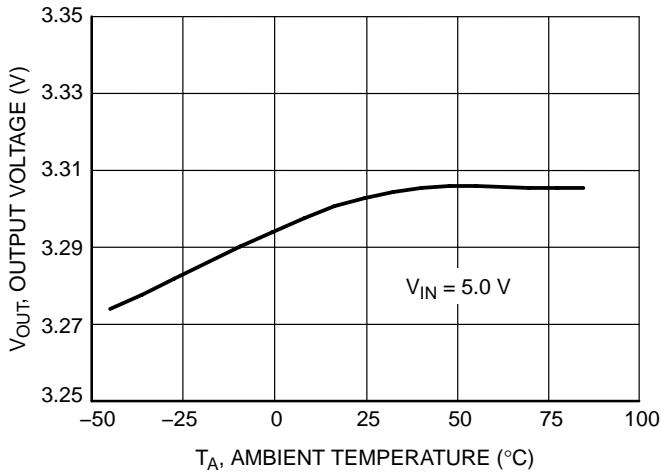


**Figure 31. Oscillator Frequency versus Ambient Temperature**

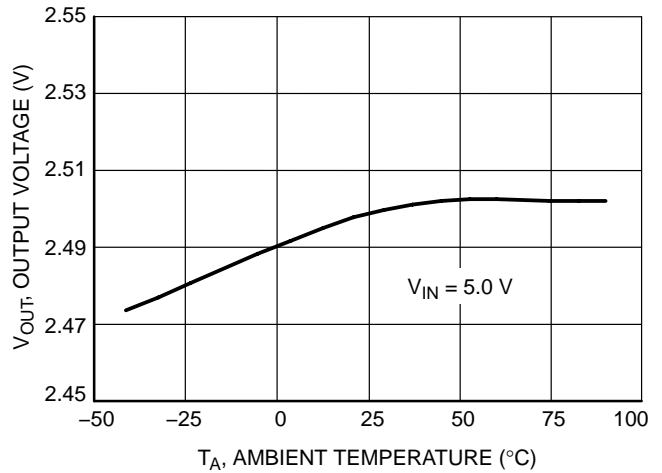


**Figure 32. PWM/PFM Switch ON Time Threshold versus Ambient Temperature**

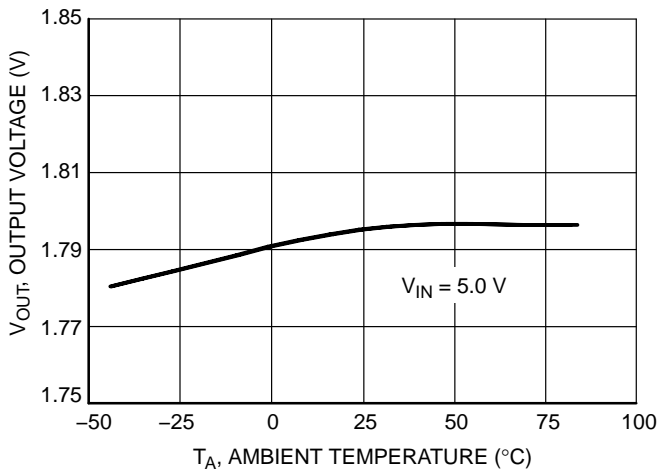
# NCP1550



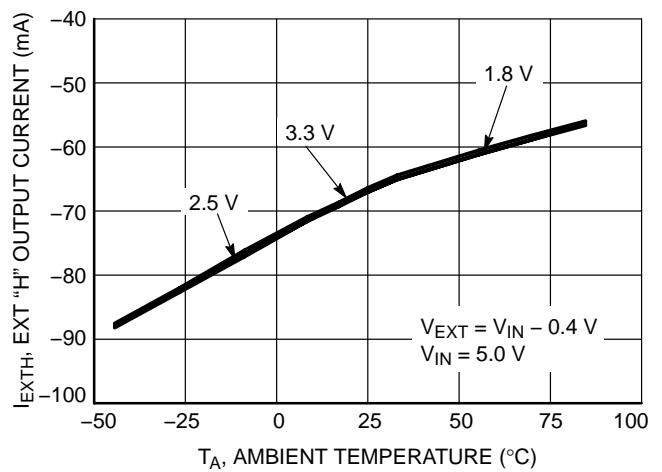
**Figure 33. NCP1550SN33T1 Output Voltage versus Ambient Temperature**



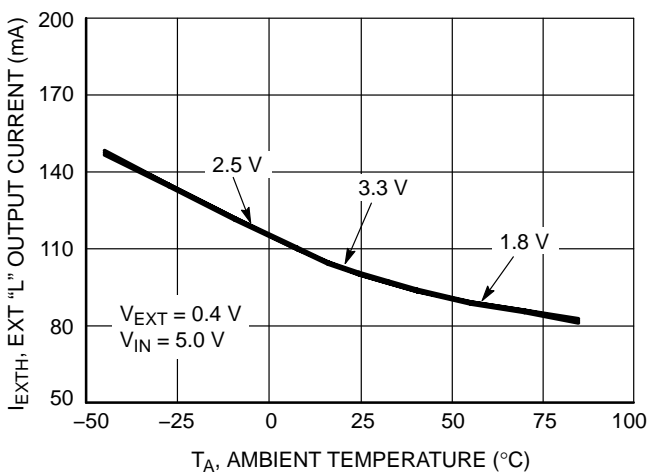
**Figure 34. NCP1550SN25T1 Output Voltage versus Ambient Temperature**



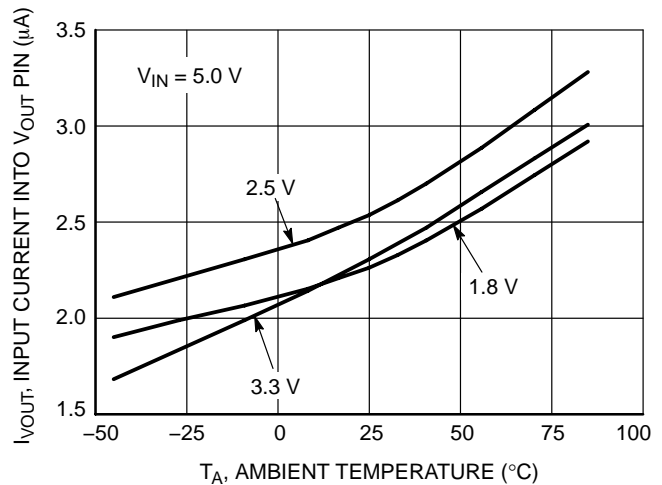
**Figure 35. NCP1550SN18T1 Output Voltage versus Ambient Temperature**



**Figure 36. NCP1550 EXT "H" Output Current versus Ambient Temperature**



**Figure 37. NCP1550 EXT "L" Output Current versus Ambient Temperature**



**Figure 38. NCP1550 Input Current into V\_OUT Pin versus Ambient Temperature**

## DETAILED OPERATING DESCRIPTION

### Detailed Operating Description

The NCP1550 series are step-down (Buck) DC-DC controllers designed primarily for use in portable applications powered by battery cells. With an appropriate external P-channel MOSFET connected, the device can provide up to 2 A loading current with high conversion efficiency. The NCP1550 series using an unique control scheme combines the advantages of Pulse-Frequency-Modulation (PFM) that can provide excellent efficiency even at light loading conditions and Constant-Frequency Pulse-Width-Modulation that can achieve high efficiency and low output voltage ripple at heavy loads. The NCP1550 working at high switching frequency makes it possible to use small size surface mount inductor and capacitors to reduce PCB area and provide better interference handling for noise sensitive applications. The simplified functional blocks of the device are shown in Figure 1 and descriptions for each of the functions are given below.

### The Internal Oscillator

An oscillator that governs the switching of a PWM control cycles is required. NCP1550 have an internal Fixed-Frequency oscillator. The oscillator frequency is trimmed to 600 kHz with an accuracy of  $\pm 15\%$ . All other timing signals needed for operation are derived from this oscillator signal.

### Voltage Reference and Soft-Start

An internal high accuracy voltage reference is included in NCP1550. This reference voltage is connected to the inverting input terminal of the error amplifier, A1, which compared with portion of the output voltage,  $V_{OUT}$  derived from an integrated voltage divider with precise trimming to give the required output voltage at  $\pm 2\%$  accuracy. NCP1550 also comes with a built-in soft-start circuit that controls the ramping up of the internal reference voltage during the power-up of the converter. This function effectively enables the output voltage to rise gradually over the specified soft-start time, 8 msec typical. This prevents the output voltage from overshooting during startup of the converter.

### Voltage Mode Pulse-Width-Modulation (PWM) Control Scheme

For normal operation, NCP1550 is working in Constant-Frequency Pulse-Width-Modulation (PWM) Voltage Mode Control. The controller operates with the internal oscillator, which generates the required ramp function to compare with the output of the error amplifier, A1. The error amplifier compares the internally divided-down output voltage with the voltage reference to produce an error

voltage at its output. This error voltage is compared with the ramp function to generate the control pulse to drive the external power switch. On a cycle-by-cycle basis, the greater the error voltage, the longer the switch is held on. Hence, corresponding corrective action will be made to keep the output voltage within regulation. Constant-Frequency PWM reduces output voltage ripple and noise, which is one of the important characteristics for noise sensitive communication applications. The high switching frequency allows small size surface mount components to improve layout compactness and reduce PC board area, and eliminate audio and emission interference.

### Power-Saving Pulse-Frequency-Modulation (PFM) Control Scheme

While the loading is decreasing, the converter enters the Discontinuous Conduction Mode (DCM) operation, which means the inductor current will decrease to zero before the next switching cycle starts. In DCM operation, the ON time for each switching cycle will decrease significantly when the output current decreases. In order to maintain a high conversion efficiency even at light load conditions, the ON time for each switching cycle is closely monitored and for any ON time smaller than the preset value, 320 nsec, the switching pulse will be skipped. As a result, when the loading current is small, the converter will be operating in a "Constant ON time (320 nsec nominal), variable OFF time" Pulse-Frequency Modulation (PFM) mode. This innovative control scheme improves the conversion efficiency for the system at light load and standby operating conditions hence extend the operating life of the battery.

### Low Power Shutdown Mode

NCP1550 can be disabled whenever the CE pin (Pin 1) is tied to GND. In shutdown, the internal reference, oscillator, control circuitry, driver and internal feedback voltage divider are turned off and the output voltage falls to 0 V. During the shutdown mode, as most of the internal functions are stopped and current paths are cut-off, the device consume extremely small current in this condition.

### Under-Voltage Lockout (UVLO)

To prevent operation of the P-Channel MOSFET below safe input voltage levels, an Undervoltage Lockout is incorporated into the NCP1550. When the input supply voltage drops below approximately 2.2 V, the comparator, CP1 will turn-off the control circuitry and shut the converter down.

## APPLICATIONS INFORMATION

**Inductor Value Calculation**

Selecting the proper inductance is a trade-off between inductor's physical size, transient response and power conversion requirements. Lower value inductor saves cost, PC board space and providing faster transient response, but result in higher ripple current and core losses. Considering an application with loading current,  $I_{OUT} = 0.5 \text{ A}$  and the inductor ripple current,  $I_{L-RIPPLE(P-P)}$  is designed to be less than 40% of the load current, i.e.  $0.5 \text{ A} \times 40\% = 0.2 \text{ A}$ . The relationship between the inductor value and inductor ripple current is given by,

$$L = \frac{T_{ON} * (V_{IN} - R_{DS(ON)} \times I_{OUT} - V_{OUT})}{I_{L-RIPPLE(P-P)}} \quad (\text{eq. 1})$$

Where  $R_{DS(ON)}$  is the ON resistance of the external P-channel MOSFET. Figure 39 is a plot for recommended inductance against nominal input voltage for different output options.

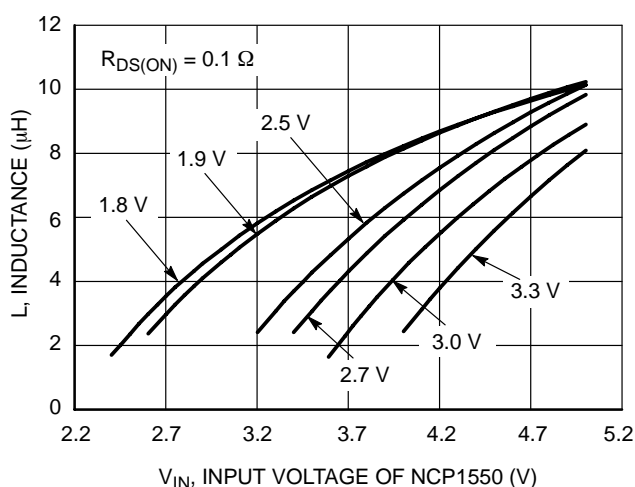


Figure 39. Inductor Selection Chart

**P-Channel Power MOSFET Selection**

An external P-channel power MOSFET must be used with the NCP1550. The key selection criteria for the power MOSFET are the gate threshold,  $V_{GS}$ , the "ON" resistance,  $R_{DS(ON)}$  and its total gate charge,  $Q_T$ . For low input voltage operation, we need to select a low gate threshold device that can work down to the minimum input voltage level.  $R_{DS(ON)}$  determines the conduction losses for each switching cycle, the lower the ON resistance, the higher the efficiency can be achieved. A power MOSFET with lower gate charge can give lower switching losses but the fast transient can cause unwanted EMI to the system. Compromise in between is required during the design stage. For 1.0 A and 2.0 A load current, NTGS3441T1 and NTGS3443T1 are tested to be appropriate for most applications.

**Flywheel Diode Selection**

The flywheel diode is turned on and carries load current during the off time. The average diode current depends on the

P-channel switch duty cycle. At high input voltages, the diode conducts most of the time. In case of  $V_{IN}$  approaches  $V_{OUT}$ , the diode conducts only a small fraction of the cycle. While the output terminals are shorted, the diode will subject to its highest stress. Under this condition, the diode must be able to safely handle the peak current circulating in the loop. So, it is important to select a flywheel diode that can meet the diode peak current and average power dissipation requirements. Under normal conditions, the average current conducted by the flywheel diode is given by:

$$I_D = \frac{V_{IN} - V_{OUT}}{V_{IN} + V_F} \times I_{OUT} \quad (\text{eq. 2})$$

Where  $I_D$  is the average diode current and  $V_F$  is the forward diode voltage drop.

A fast switching diode must also be used to optimize efficiency. Schottky diodes are a good choice for low forward drop and fast switching times.

**Input and Output Capacitor Selection ( $C_{IN}$  and  $C_{OUT}$ )**

In continuous mode operation, the source current of the P-channel MOSFET is a square wave of duty cycle  $(V_{OUT} + V_F)/V_{IN}$ . To prevent large input voltage transients, a low ESR input capacitor that can support the maximum RMS input current must be selected. The maximum RMS input current,  $I_{RMS(MAX)}$  can be estimated by the equation in below:

$$I_{RMS(MAX)} \approx I_{OUT} \times \frac{V_{OUT}(V_{IN} - V_{OUT})^{1/2}}{V_{IN}} \quad (\text{eq. 3})$$

Above estimation has a maximum value at  $V_{IN} = 2V_{OUT}$ , where  $I_{RMS(MAX)} = I_{OUT}/2$ . As a general practice, this simple worst-case condition is used for design.

Selection of the output capacitor,  $C_{OUT}$  is primarily governed by the required effective series resistance (ESR) of the capacitor. Typically, once the ESR requirement is met, the capacitance will be adequate for filtering. The output voltage ripple,  $V_{RIPPLE}$  is approximated by:

$$V_{RIPPLE} \approx I_{L-RIPPLE(P-P)} \times \left( \text{ESR} + \frac{1}{4 F_{OSC} C_{OUT}} \right) \quad (\text{eq. 4})$$

Where  $F_{OSC}$  is the switching frequency and ESR is the effective series resistance of the output capacitor.

From equation (4), it can be noted that the output voltage ripple contributed by two parts. For most of the case, the major contributor is the capacitor ESR. Ordinary aluminum-electrolytic capacitors have high ESR and should be avoided. Higher quality Low ESR aluminum-electrolytic capacitors are acceptable and relatively inexpensive. For even better performance, Low ESR tantalum capacitors should be used. Surface-mount tantalum capacitors are better and provide neat and compact solution for space sensitive applications.

# NCP1550

## PCB Layout Recommendations

Good PCB layout plays an important role in switching mode power conversion. Careful PCB layout can help to minimize ground bounce, EMI noise and unwanted feedbacks that can affect the performance of the converter. Suggested hints below can be used as a guideline in most situations.

### Grounding

Star-ground connection should be used to connect the output power return ground, the input power return ground and the device power ground together at one point. All high current running paths must be thick enough for current flowing through and producing insignificant voltage drop along the path. Feedback signal path must be separated from the main current path and sensing directly at the anode of the output capacitor.

## Components Placement

Power components, i.e. input capacitor, inductor and output capacitor, must be placed as close together as possible. All connecting traces must be short, direct and thick. High current flowing and switching paths must be kept away from the feedback ( $V_{OUT}$ , pin 3) terminal to avoid unwanted injection of noise into the feedback path.

### Feedback Path

Feedback of the output voltage must be a separate trace separated from the power path. The output voltage sensing trace to the feedback ( $V_{OUT}$ , pin 3) pin should be connected to the output voltage directly at the anode of the output capacitor.

## External Component Reference Data

Device	$V_{OUT}$	Inductor Model	Inductor (L)	External MOSFET (M)	Diode (SD)	Output and Input Capacitor $C_{OUT}/C_{IN}$
NCP1550SN18T1	1.8 V	CDD5D23 6R8 (1A) CDRH6D38 6R8 (2A) Sumida	6.8 $\mu$ H	NTGS3441T1 (1A) NTGS3443T1 (2A) ON Semiconductor	MBRM120LT3 ON Semiconductor	33 $\mu$ F/33 $\mu$ F (1A) 68 $\mu$ F/33 $\mu$ F (2A) KEMET (T494 series)
NCP1550SN19T1	1.9 V	CDC5D23 6R8 (1A) CDRH6D38 6R8 (2A) Sumida	6.8 $\mu$ H	NTGS3441T1 (1A) NTGS3443T1 (2A) ON Semiconductor	MBRM120LT3 ON Semiconductor	33 $\mu$ F/33 $\mu$ F (1A) 68 $\mu$ F/33 $\mu$ F (2A) KEMET (T494 series)
NCP1550SN25T1	2.5 V	CDC5D23 5R6 (1A) CDRH6D38 5R0 (2A) Sumida	5.6 $\mu$ H 5.0 $\mu$ H	NTGS3441T1 (1A) NTGS3443T1 (2A) ON Semiconductor	MBRM120LT3 ON Semiconductor	33 $\mu$ F/33 $\mu$ F (1A) 68 $\mu$ F/33 $\mu$ F (2A) KEMET (T494 series)
NCP1550SN27T1	2.7 V	CDC5D23 5R6 (1A) CDRH6D38 5R0 (2A) Sumida	5.6 $\mu$ H 5.0 $\mu$ H	NTGS3441T1 (1A) NTGS3443T1 (2A) ON Semiconductor	MBRM120LT3 Semiconductor	33 $\mu$ F/33 $\mu$ F (1A) 68 $\mu$ F/33 $\mu$ F (2A) KEMET (T494 series)
NCP1550SN30T1	3.0 V	CDC5D23 4R7 (1A) CDRH6D28 5R0 (2A) Sumida	5.6 $\mu$ H 5.0 $\mu$ H	NTGS3441T1 (1A) NTGS3443T1 (2A) ON Semiconductor	MBRM120LT3 ON Semiconductor	33 $\mu$ F/33 $\mu$ F (1A) 68 $\mu$ F/33 $\mu$ F (2A) KEMET (T494 series)
NCP1550SN33T1	3.3 V	CD43 3R3 (1A) CDRH6D38 3R3 (2A) Sumida	3.3 $\mu$ H	NTGS3441T1 (1A) NTGS3443T1 (2A) ON Semiconductor	MBRM120LT3 ON Semiconductor	68 $\mu$ F/33 $\mu$ F (1A) 100 $\mu$ F/68 $\mu$ F (2A) KEMET (T494 series)

# NCP1550

## ORDERING INFORMATION

Part Number	Output Voltage (V <sub>OUT</sub> )	Switching Frequency	Device Marking	Package	Shipping <sup>†</sup>
NCP1550SN33T1	3.3 V	600 kHz	DCD	TSOP-5	3000 Tape & Reel
NCP1550SN33T1G	3.3 V		DCD	TSOP-5 (Pb-Free)	
NCP1550SN30T1	3.0 V		DBF	TSOP-5	
NCP1550SN30T1G	3.0 V		DBF	TSOP-5 (Pb-Free)	
NCP1550SN27T1	2.7 V		DCB	TSOP-5	
NCP1550SN27T1G	2.7 V		DCB	TSOP-5 (Pb-Free)	
NCP1550SN25T1	2.5 V		DCA	TSOP-5	
NCP1550SN25T1G	2.5 V		DCA	TSOP-5 (Pb-Free)	
NCP1550SN19T1	1.9 V		DBE	TSOP-5	
NCP1550SN19T1G	1.9 V		DBE	TSOP-5 (Pb-Free)	
NCP1550SN18T1	1.8 V		DBZ	TSOP-5	
NCP1550SN18T1G	1.8 V		DBZ	TSOP-5 (Pb-Free)	

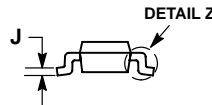
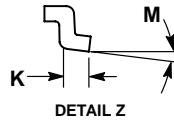
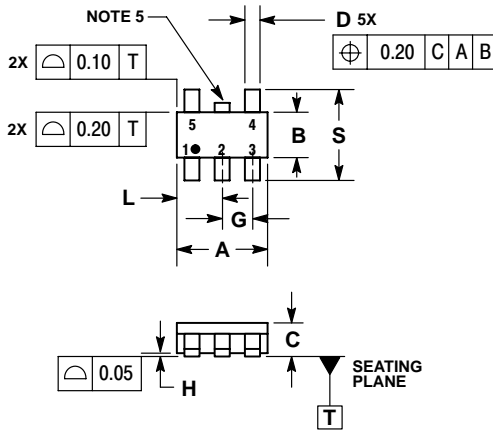
<sup>†</sup>For information on tape and reel specifications, including part orientation and tape sizes, please refer to our Tape and Reel Packaging Specifications Brochure, BRD8011/D.



# NCP1550

## PACKAGE DIMENSIONS

THIN SOT23-5/TSOP-5/SC59-5  
SN SUFFIX  
CASE 483-02  
ISSUE F

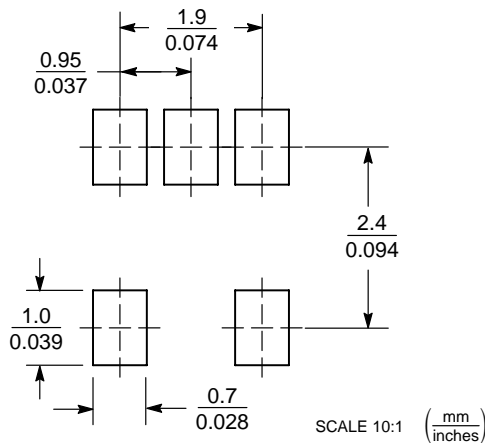


NOTES:

1. DIMENSIONING AND TOLERANCING PER ASME Y14.5M, 1994.
2. CONTROLLING DIMENSION: MILLIMETERS.
3. MAXIMUM LEAD THICKNESS INCLUDES LEAD FINISH THICKNESS. MINIMUM LEAD THICKNESS IS THE MINIMUM THICKNESS OF BASE MATERIAL.
4. DIMENSIONS A AND B DO NOT INCLUDE MOLD FLASH, PROTRUSIONS, OR GATE BURRS.
5. OPTIONAL CONSTRUCTION: AN ADDITIONAL TRIMMED LEAD IS ALLOWED IN THIS LOCATION. TRIMMED LEAD NOT TO EXTEND MORE THAN 0.2 FROM BODY.

DIM	MILLIMETERS	
	MIN	MAX
A	3.00 BSC	
B	1.50 BSC	
C	0.90	1.10
D	0.25	0.50
G	0.95 BSC	
H	0.01	0.10
J	0.10	0.26
K	0.20	0.60
L	1.25	1.55
M	0°	10°
S	2.50	3.00

### SOLDERING FOOTPRINT\*



\*For additional information on our Pb-Free strategy and soldering details, please download the ON Semiconductor Soldering and Mounting Techniques Reference Manual, SOLDERRM/D.

ON Semiconductor and are registered trademarks of Semiconductor Components Industries, LLC (SCILLC). SCILLC reserves the right to make changes without further notice to any products herein. SCILLC makes no warranty, representation or guarantee regarding the suitability of its products for any particular purpose, nor does SCILLC assume any liability arising out of the application or use of any product or circuit, and specifically disclaims any and all liability, including without limitation special, consequential or incidental damages. "Typical" parameters which may be provided in SCILLC data sheets and/or specifications can and do vary in different applications and actual performance may vary over time. All operating parameters, including "Typicals" must be validated for each customer application by customer's technical experts. SCILLC does not convey any license under its patent rights nor the rights of others. SCILLC products are not designed, intended, or authorized for use as components in systems intended for surgical implant into the body, or other applications intended to support or sustain life, or for any other application in which the failure of the SCILLC product could create a situation where personal injury or death may occur. Should Buyer purchase or use SCILLC products for any such unintended or unauthorized application, Buyer shall indemnify and hold SCILLC and its officers, employees, subsidiaries, affiliates, and distributors harmless against all claims, costs, damages, and expenses, and reasonable attorney fees arising out of, directly or indirectly, any claim of personal injury or death associated with such unintended or unauthorized use, even if such claim alleges that SCILLC was negligent regarding the design or manufacture of the part. SCILLC is an Equal Opportunity/Affirmative Action Employer. This literature is subject to all applicable copyright laws and is not for resale in any manner.

### PUBLICATION ORDERING INFORMATION

LITERATURE FULFILLMENT:  
Literature Distribution Center for ON Semiconductor  
P.O. Box 5163, Denver, Colorado 80217 USA  
Phone: 303-675-2175 or 800-344-3860 Toll Free USA/Canada  
Fax: 303-675-2176 or 800-344-3867 Toll Free USA/Canada  
Email: orderlit@onsemi.com

N. American Technical Support: 800-282-9855 Toll Free  
USA/Canada  
Europe, Middle East and Africa Technical Support:  
Phone: 421 33 790 2910  
Japan Customer Focus Center  
Phone: 81-3-5773-3850

ON Semiconductor Website: [www.onsemi.com](http://www.onsemi.com)  
Order Literature: <http://www.onsemi.com/orderlit>

For additional information, please contact your local Sales Representative

# Mouser Electronics

Authorized Distributor

Click to View Pricing, Inventory, Delivery & Lifecycle Information:

## ON Semiconductor:

[NCP1550SN18T1](#) [NCP1550SN18T1G](#) [NCP1550SN19T1](#) [NCP1550SN19T1G](#) [NCP1550SN25T1](#)  
[NCP1550SN25T1G](#) [NCP1550SN27T1](#) [NCP1550SN27T1G](#) [NCP1550SN30T1](#) [NCP1550SN30T1G](#) [NCP1550SN33T1](#)  
[NCP1550SN33T1G](#)