

LP2975 MOSFET LDO Driver/Controller

General Description

A high-current LDO regulator is simple to design with the LP2975 LDO Controller. Using an external P-FET, the LP2975 will deliver an ultra low dropout regulator with extremely low quiescent current.

High open loop gain assures excellent regulation and ripple rejection performance.

The trimmed internal bandgap reference provides precise output voltage over the entire operating temperature range.

Dropout voltage is "user selectable" by sizing the external FET: the minimum input-output voltage required for operation is the maximum load current multiplied by the $R_{DS(ON)}$ of the FET.

Overcurrent protection of the external FET is easily implemented by placing a sense resistor in series with V_{IN} . The 57 mV detection threshold of the current sense circuitry minimizes dropout voltage and power dissipation in the resistor.

The standard product versions available provide output voltages of 12V, 5V, or 3.3V with guaranteed 25°C accuracy of 1.5% ("A" grade) and 2.5% (standard grade).

Features

- Simple to use, few external components
- Ultra-small mini SO-8 package
- 1.5% (A grade) precision output voltage
- Low-power shutdown input
- $< 1 \mu A$ in shutdown
- Low operating current (180 μA typical @ $V_{IN} = 5V$)
- Wide supply voltage range (1.8V to 24V)
- Built-in current limit amplifier
- Overtemperature protection
- 12V, 5V, and 3.3V standard output voltages
- Can be programmed using external divider
- $-40^{\circ}C$ to $+125^{\circ}C$ junction temperature range

Applications

- High-current 5V to 3.3V regulator
- Post regulator for switching converter
- Current-limited switch

Block Diagram

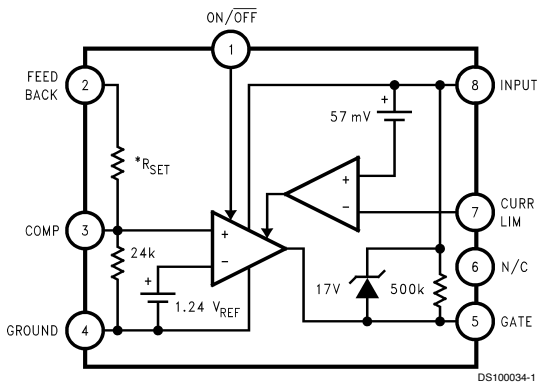

* R_{SET} values are: 208k for 12V part, 72.8k for 5V part, and 39.9k for 3.3V part.

Connection Diagram

Surface Mount Mini SO-8 Package

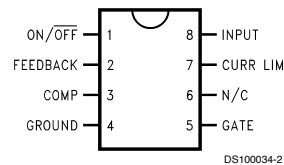

Top View
For Order Numbers
See Table 1 of this Document
See NS Package Number MUA08A

Ordering Information

TABLE 1. Package Marking and Ordering Information

Output Voltage	Grade	Order Information	Package Marking	Supplied As:
12	A	LP2975AIMMX-12	L47A	3.5k Units on Tape and Reel
12	A	LP2975AIMM-12	L47A	250 Units on Tape and Reel
12	STD	LP2975IMMX-12	L47B	3.5k Units on Tape and Reel
12	STD	LP2975IMM-12	L47B	250 Units on Tape and Reel
5.0	A	LP2975AIMMX-5.0	L46A	3.5k Units on Tape and Reel
5.0	A	LP2975AIMM-5.0	L46A	250 Units on Tape and Reel
5.0	STD	LP2975IMMX-5.0	L46B	3.5k Units on Tape and Reel
5.0	STD	LP2975IMM-5.0	L46B	250 Units on Tape and Reel
3.3	A	LP2975AIMMX-3.3	L45A	3.5k Units on Tape and Reel
3.3	A	LP2975AIMM-3.3	L45A	250 Units on Tape and Reel
3.3	STD	LP2975IMMX-3.3	L45B	3.5k Units on Tape and Reel
3.3	STD	LP2975IMM-3.3	L45B	250 Units on Tape and Reel

Absolute Maximum Ratings (Note 1)

If Military/Aerospace specified devices are required, please contact the National Semiconductor Sales Office/Distributors for availability and specifications.

Storage Temperature Range	-65°C to +150°C
Operating Junction Temperature Range	-40°C to +125°C
Lead Temp. (Soldering, 5 seconds)	260°C
ESD Rating	2 kV
Power Dissipation (Note 2)	Internally Limited

Input Supply Voltage (Survival)	-0.3V to +26V
Input Supply Voltage (Operating)	+1.8V to +24V
Current Limit Pins (Survival)	-0.3V to +V _{IN}
Comp Pin (Survival)	-0.3V to +2V
Gate Pin (Survival)	-0.3V to +V _{IN}
ON/OFF Pin (Survival)	-0.3V to +20V
Feedback Pin (Survival)	-0.3V to +24V

Electrical Characteristics

Limits in standard typeface are for T_J = 25°C, and limits in **boldface type** apply over the full operating temperature range. Unless otherwise specified; V_{ON/OFF} = 1.5V, V_{IN} = 15V.

Symbol	Parameter	Conditions	Typ	LM2975AI-X.X (Note 3)		LM2975I-X.X (Note 3)		Units
				Min	Max	Min	Max	
V _{REG}	Regulation Voltage (12V Versions)	12.5 < V _{IN} < 24V (V _{IN} - 0.5V) > V _{GATE} > (V _{IN} - 5V)	12.0	11.820 11.640	12.180 12.360	11.700 11.520	12.300 12.480	V
	Regulation Voltage (5V Versions)	5.5 < V _{IN} < 24V (V _{IN} - 0.5V) > V _{GATE} > (V _{IN} - 4.5V)	5.0	4.925 4.850	5.075 5.150	4.875 4.800	5.125 5.200	
	Regulation Voltage (3.3V Versions)	3.8 < V _{IN} < 24V (V _{IN} - 0.5V) > V _{GATE} > (V _{IN} - 3.3V)	3.3	3.250 3.201	3.350 3.399	3.217 3.168	3.383 3.432	
V _{COMP}	Comp Pin Voltage	V _{REG} < V _{IN} < 24V	1.240	1.215 1.209	1.265 1.271	1.203 1.196	1.277 1.284	V
I _Q	Quiescent Current	V _{IN} = 5V	180		240 320		240 320	μA
		V _{ON/OFF} = 0V	0.01		1		1	
V _{CL}	Current Limit Sense Voltage	V _{IN} = 15V V _{FB} = 0.9 X V _{REG}	57	45 39	69 72	45 39	69 72	mV
V _{ON/OFF}	ON/OFF Threshold	Output = ON	0.94	1.10 1.20		1.10 1.20		V
		Output = OFF	0.87		0.70 0.40		0.70 0.40	
I _{ON/OFF}	ON/OFF Input Bias Current	V _{ON/OFF} = 1.5V	34		50 75		50 75	μA
I _G	Gate Drive Current (Sourcing)	V _G = 7.5V V _{FB} = 1.1 X V _{REG}	3.5	1.3 0.3		1.3 0.3		mA
	Gate Drive Current (Sinking)	V _G = 7.5V V _{FB} = 0.9 X V _{REG}	1100	350 40		350 40		μA
V _{G(MIN)}	Gate Clamp Voltage	V _{IN} = 24V V _{FB} = 0.9 X V _{REG}	17	15	19	15	19	V
R(V _{IN} -G)	Resistance from Gate to V _{IN}	V _{IN} = 24V V _{ON/OFF} = 0	500					kΩ
$\frac{\Delta V_{GATE}}{\Delta V_{COMP}}$	Open Loop Voltage Gain	V _{IN} = 15V 0.5V ≤ V _{GATE} ≤ 13	5000					V/V

Note 1: Absolute maximum ratings indicate limits beyond which damage to the component may occur. Electrical specifications do not apply when operating the device outside of its rated operating conditions.

Note 2: The LP2975 has internal thermal shutdown which activates at a die temperature of about 150°C. It should be noted that the power dissipated within the LP2975 is low enough that this protection circuit should never activate due to self-heating, even at elevated ambient temperatures.

Electrical Characteristics (Continued)

Note 3: Limits are 100% production tested at 25°C. Limits over the operating temperature range are guaranteed through correlation using Statistical Quality Control (SOC) methods. The limits are used to calculate National's Average Outgoing Quality Level (AOQL).

Typical Application Circuits

5V - 3.3V @ 5A LDO Regulator

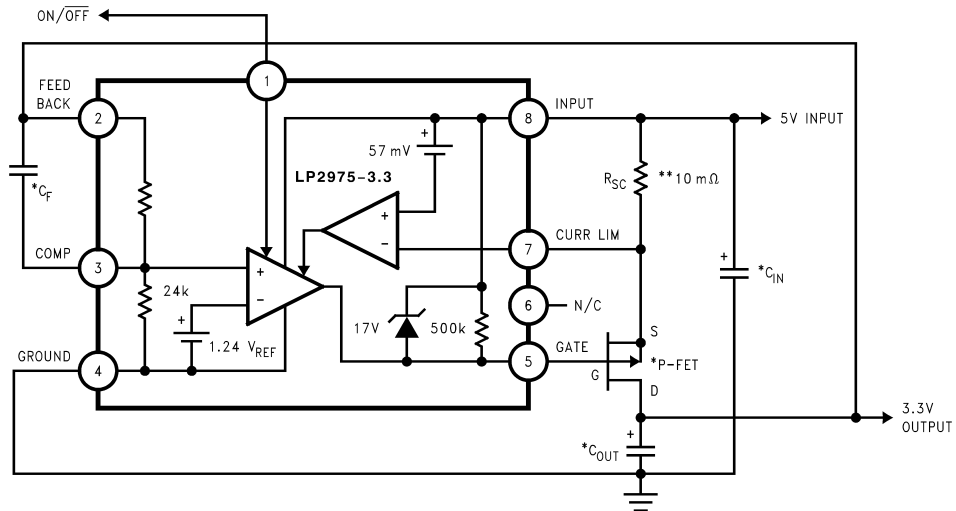

DS100034-3

*See Application Hints.

**If current limiting is not required, short out this resistor.

Adjustable Voltage 5A LDO Regulator

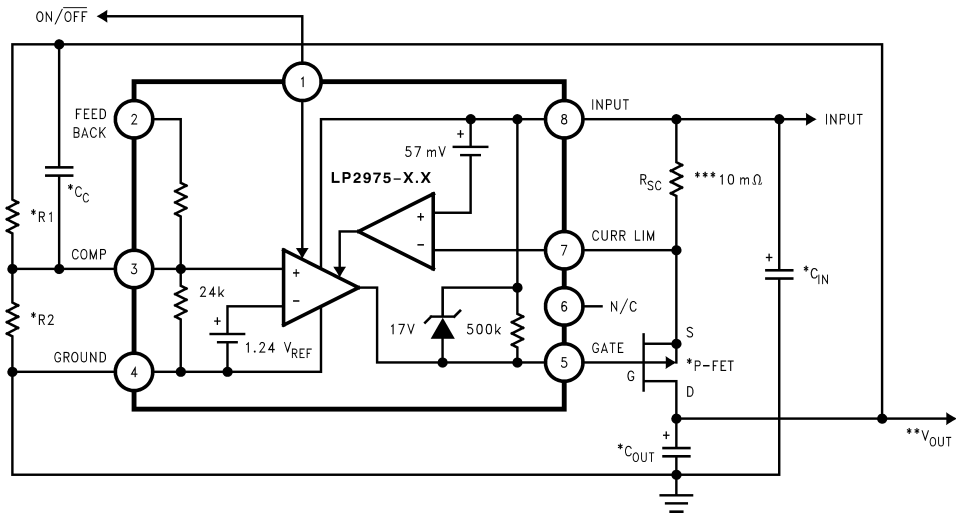

DS100034-4

*See Application Hints.

$$**V_{OUT} = 1.24 \times \left(\frac{R1}{R_{EQ}} + 1 \right) \text{ where } R_{EQ} = \frac{R2 \times 24K}{R2 + 24K}$$

***If current limiting is not required, short out this resistor.

Typical Performance Characteristics Unless otherwise specified: $T_A = 25^\circ\text{C}$, $C_{IN} = 1 \mu\text{F}$, ON/OFF pin is tied to 1.5V.

Minimum Operating Voltage

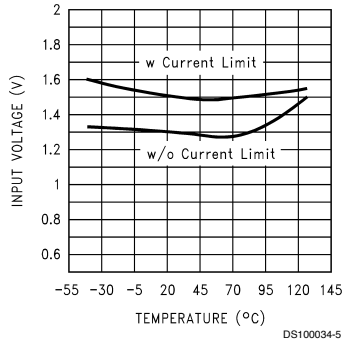

V_{IN} Referred Gate Clamp Voltage

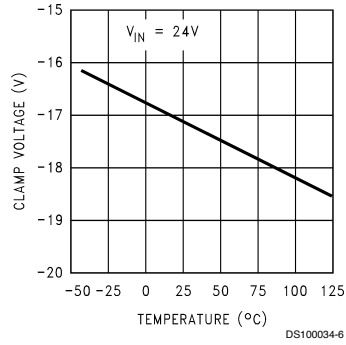

ON/OFF Threshold

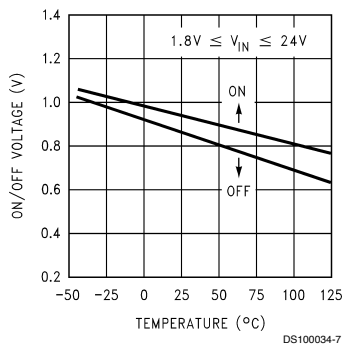

Current Limit Sense Voltage

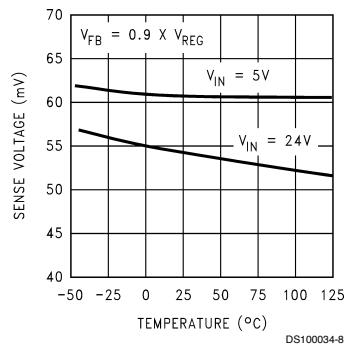

ON/OFF Pin Current

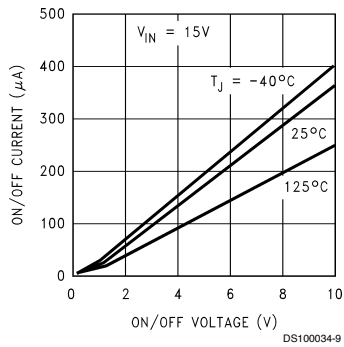

Supply Current

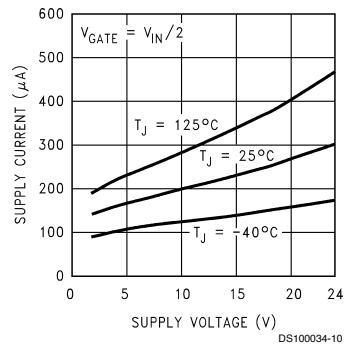

Typical Performance Characteristics Unless otherwise specified: $T_A = 25^\circ\text{C}$, $C_{IN} = 1\ \mu\text{F}$, ON/OFF pin is tied to 1.5V. (Continued)

ON/OFF Input Resistance

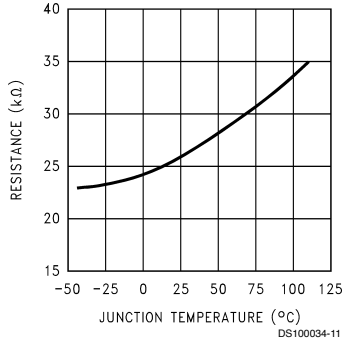

Gate Current

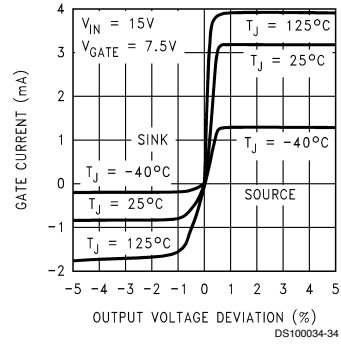

Gate-Ground Saturation

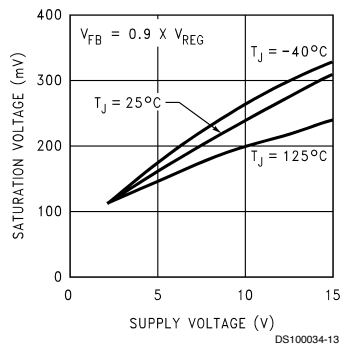

Line Regulation

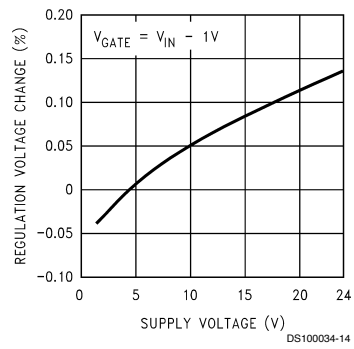

Load Regulation

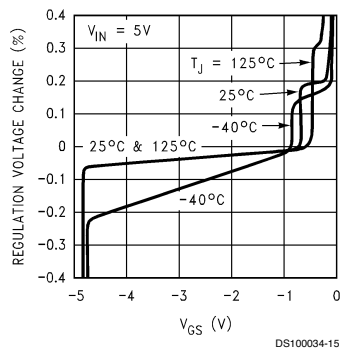

Leakage Current

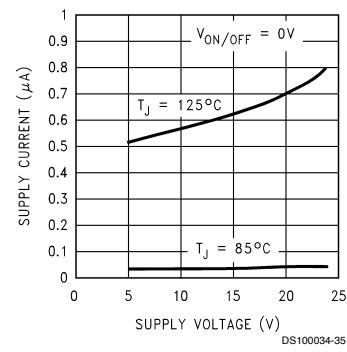

Typical Performance Characteristics Unless otherwise specified: $T_A = 25^\circ\text{C}$, $C_{IN} = 1\ \mu\text{F}$, ON/OFF pin is tied to 1.5V. (Continued)

Controller Gain and Phase Response

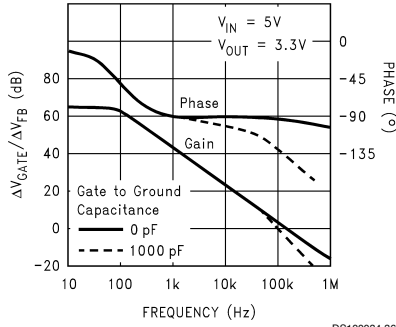

Reference Designs

The LP2975 controller can be used with virtually any P-channel MOSFET to build a wide variety of linear voltage regulators.

Since it would be impossible to document all the different voltage and current combinations that could be built, a number of reference designs will be presented along with performance data for each.

THE PERFORMANCE DATA SHOWN IS ACTUAL TEST DATA, BUT IS **NOT GUARANTEED**.

DESIGN #1: $V_{OUT} = 5V @ 5A$ (Refer to Typical Application Circuits)

COMPONENTS:

- $C_{IN} = 82\ \mu\text{F}$ Aluminum Electrolytic
- $C_{OUT} = 120\ \mu\text{F}$ Aluminum Electrolytic
- $C_F = 220\ \text{pF}$
- $R_{SC} = 10\ \text{m}\Omega$
- P-FET = NDP6020P

Heatsink: (assuming $V_{IN} \leq 7V$ and $T_A \leq 60^\circ\text{C}$) if protection against a *continuous* short-circuit is required, a heatsink with $\theta_{S-A} \leq 1.5^\circ\text{C/W}$ must be used. However, if continuous short-circuit survivability is not needed, a heatsink with $\theta_{S-A} \leq 6^\circ\text{C/W}$ is adequate.

PERFORMANCE DATA:

Dropout Voltage

Dropout voltage is defined as the minimum input-to-output differential voltage required by the regulator to keep the output in regulation. It is measured by reducing V_{IN} until the output voltage drops below the nominal value (the nominal value is the output voltage measured with $V_{IN} = 5.5V$). $I_L = 5A$ for this test.

DROPOUT VOLTAGE = 323 mV

Load Regulation

Load regulation is defined as the maximum change in output voltage as the load current is varied. It is measured by changing the load resistance and recording the minimum/

maximum output voltage. The measured change in output voltage is divided by the nominal output voltage and expressed as a percentage. $V_{IN} = 5.6V$ for this test.

$5\ \text{mA} \leq I_L \leq 5A$: LOAD REGULATION = 0.012%

$0 \leq I_L \leq 5A$: LOAD REGULATION = 0.135%

Line Regulation

Line regulation is defined as the maximum change in output voltage as the input voltage is varied. It is measured by changing the input voltage and recording the minimum/maximum output voltage. The measured change in output voltage is divided by the nominal output voltage and expressed as a percentage. $I_L = 5A$ for this test.

$5.4V \leq V_{IN} \leq 10V$: LINE REGULATION = 0.03%

Output Noise Voltage

Output noise voltage was measured by connecting a wide-band AC voltmeter (HP 400E) directly across the output capacitor. $V_{IN} = 6V$ and $I_L = 5A$ for this test.

NOISE = 75 μV (rms)

Transient Response

Transient response is defined as the change in output voltage which occurs after the load current is suddenly changed. $V_{IN} = 5.6V$ for this test.

The load resistor is connected to the regulator output using a switch so that the load current increases from 0 to 5A abruptly. The change in output voltage is shown in the scope photo below (the vertical scale is 200 mV/division and the horizontal scale is 10 μs /division). The regulator nominal output (5V) is located on the center line of the photo.

The output shows a maximum change of about -600 mV compared to nominal. This is due to the relatively small output capacitor chosen for this design. Increasing C_{OUT} greatly improves transient response (see Designs #2 and #3).

Reference Designs (Continued)

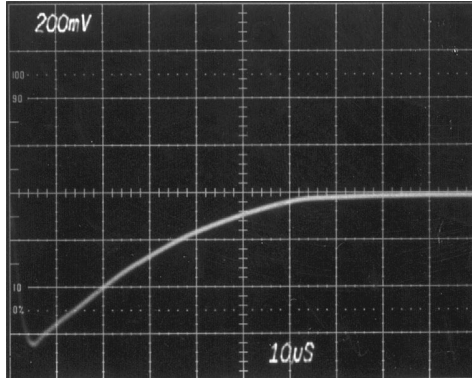

Transient Response for 0–0.5A Load Step

DESIGN #2: $V_{OUT} = 3V @ 0.5A$ (Refer to Typical Application Circuits, Adjustable Voltage Regulator)

COMPONENTS:

$C_{IN} = 68 \mu F$ Tantalum

$C_{OUT} = 2 \times 68 \mu F$ Tantalum

$C_C = 470 pF$

$R1 = 237 k\Omega, 1\%$

$R2 = \text{NOT USED}$

$R_{SC} = 0.1\Omega$

Tie feedback pin to V_{OUT}

P-FET = NDT452P

Heatsink: Tab of N-FET is soldered down to 0.6 in² copper area on PC board.

Output Voltage Adjustment: For this application, a 3.3V part is "trimmed" down to 3V by using a single external 237 k Ω resistor at R1, which parallels the internal 39.9 k Ω resistor (reducing the effective resistance to 34.2 k Ω).

Because the tempco of the external resistor will not match the tempco of the internal resistor (which is typically 3000 ppm), this method of adjusting V_{OUT} by using a single resistor is only recommended in cases where the output voltage is adjusted $\leq 10\%$ away from the nominal value.

PERFORMANCE DATA:

Dropout Voltage

Dropout voltage is defined as the minimum input-to-output differential voltage required by the regulator to keep the output in regulation. It is measured by reducing V_{IN} until the output voltage drops below the nominal value (the nominal value is the output voltage measured with $V_{IN} = 5V$). $I_L = 0.5A$ for this test.

$$\text{DROPOUT VOLTAGE} = 141 \text{ mV}$$

Load Regulation

Load regulation is defined as the maximum change in output voltage as the load current is varied. It is measured by changing the load resistance and recording the minimum/

maximum output voltage. The measured change in output voltage is divided by the nominal output voltage and expressed as a percentage. $V_{IN} = 3.5V$ for this test.

$$0 \leq I_L \leq 0.5A: \text{LOAD REGULATION} = 0.034\%$$

Line Regulation

Line regulation is defined as the maximum change in output voltage as the input voltage is varied. It is measured by changing the input voltage and recording the minimum/maximum output voltage. The measured change in output voltage is divided by the nominal output voltage and expressed as a percentage. $I_L = 0.5A$ for this test.

$$3.5V \leq V_{IN} \leq 6V: \text{LINE REGULATION} = 0.017\%$$

Output Noise Voltage

Output noise voltage was measured by connecting a wide-band AC voltmeter (HP 400E) directly across the output capacitor. $V_{IN} = 5V$ and $I_L = 0.5A$ for this test.

$$\text{NOISE} = 85 \mu V \text{ (rms)}$$

Transient Response

Transient response is defined as the change in output voltage which occurs after the load current is suddenly changed. $V_{IN} = 3.5V$ for this test.

The load resistor is connected to the regulator output using a switch so that the load current increases from 0 to 0.5A abruptly. The change in output voltage is shown in the scope photo (the vertical scale is 20 mV/division and the horizontal scale is 50 μs /division). The regulator nominal output (3V) is located on the center line of the photo. A maximum change of about -50 mV is shown.

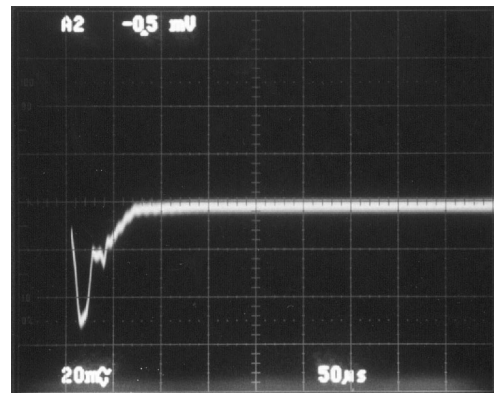

Transient Response for 0–0.5A Load Step

Minimizing C_{OUT}

It is often desirable to decrease the value of C_{OUT} to save cost and reduce size. The design guidelines suggest selecting C_{OUT} to set the first pole $\leq 200 \text{ Hz}$ (see later section *Output Capacitor*), but this is not an absolute requirement in all cases.

The effect of reducing C_{OUT} is to decrease phase margin. As phase margin is decreased, the output ringing will increase when a load step is applied to the output. Eventually, if C_{OUT} is made small enough, the regulator will oscillate.

To demonstrate these effects, the value of C_{OUT} in reference design #2 is halved by removing one of the two 68 μF output capacitors and the transient response test is repeated (see

Reference Designs (Continued)

photo below). The total overshoot increases from -50 mV to about -75 mV, and the second “ring” on the transient is noticeably larger.

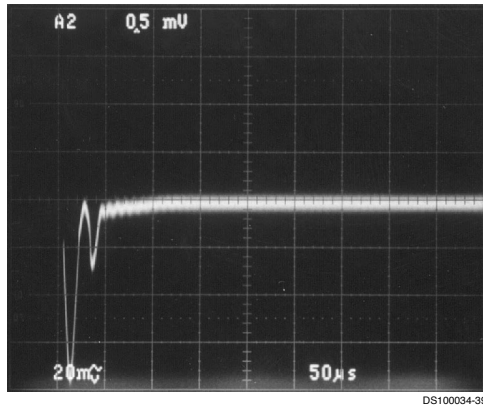

Transient Response with Output Capacitor Halved

The design is next tested with only a 4.7 μF output capacitor (see scope photo below). Observe that the vertical scale has been increased to 100 mV/division to accommodate the -250 mV undershoot. More important is the severe ringing as the transient decays. Most designers would recognize this immediately as the warning sign of a marginally stable design.

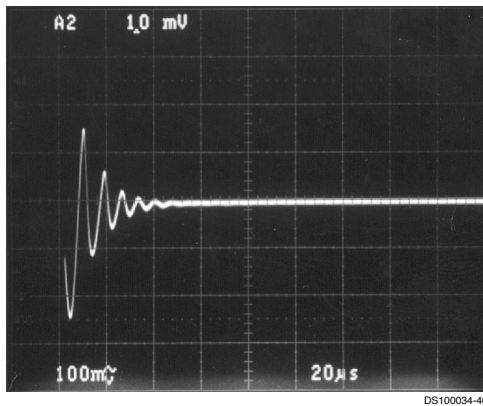

Transient Response with Only 4.7 μF Output Cap

The reason this design is marginally stable is that the 4.7 μF output capacitor (along with the 6Ω output load) sets the pole f_p at 5 kHz. Analysis shows that the unity-gain frequency of the loop is increased to about 100 kHz, allowing the FET’s gate capacitance pole f_{pg} to cause significant phase shift before the loop gain goes below unity. Also, because of the low output voltage, the feedforward capacitor provides less than 10° of positive phase shift. For good stability, the output capacitor needs to be larger than 4.7 μF .

For detailed information on stability and phase margin, see the *Application Hints* section.

DESIGN #3: $V_{\text{OUT}} = 1.5\text{V}$ @ 6A . (Refer to Typical Application Circuits, Adjustable Voltage Regulator)

COMPONENTS:

$C_{\text{IN}} = 1000$ μF Aluminum Electrolytic
 $C_{\text{OUT}} = 4 \times 330$ μF OSCON Aluminum Electrolytic
 $C_{\text{C}} = \text{NOT USED}$
 $R_1 = 261\Omega$, 1%
 $R_2 = 1.21$ k Ω , 1%
 $R_{\text{SC}} = 6$ m Ω
P-FET = NDP6020P

Heatsink: (Assuming $V_{\text{IN}} \leq 3.3\text{V}$ and $T_A \leq 60^\circ\text{C}$) if protection against a *continuous* short-circuit is required, a heatsink with $\theta_{\text{S-A}} < 2.5^\circ\text{C/W}$ must be used. However, if continuous short-circuit survivability is not needed, a heatsink with $\theta_{\text{S-A}} < 7^\circ\text{C/W}$ is adequate.

PERFORMANCE DATA:

Dropout Voltage

Dropout voltage is defined as the minimum input-to-output differential voltage required by the regulator to keep the output in regulation. It is measured by reducing V_{IN} until the output voltage drops below the nominal value (the nominal value is the output voltage measured with $V_{\text{IN}} = 3.3\text{V}$). $I_L = 6\text{A}$ for this test.

$$\text{DROPOUT VOLTAGE} = 0.68\text{V}$$

Load Regulation

Load regulation is defined as the maximum change in output voltage as the load current is varied. It is measured by changing the load resistance and recording the minimum/maximum output voltage. The measured change in output voltage is divided by the nominal output voltage and expressed as a percentage. $V_{\text{IN}} = 3.3\text{V}$ for this test.

$$0 \leq I_L \leq 6\text{A}; \text{LOAD REGULATION} = 0.092\%$$

Line Regulation

Line regulation is defined as the maximum change in output voltage as the input voltage is varied. It is measured by changing the input voltage and recording the minimum/maximum output voltage. The measured change in output voltage is divided by the nominal output voltage and expressed as a percentage. $I_L = 6\text{A}$ for this test.

$$3.3\text{V} \leq V_{\text{IN}} \leq 5\text{V}; \text{LINE REGULATION} = 0.033\%$$

Output Noise Voltage

Output noise voltage was measured by connecting a wide-band AC voltmeter (HP 400E) directly across the output capacitor. $V_{\text{IN}} = 3.3\text{V}$ and $I_L = 6\text{A}$ for this test.

$$\text{NOISE} = 60 \mu\text{V (rms)}$$

Transient Response

Transient response is defined as the change in output voltage which occurs after the load current is suddenly changed. $V_{\text{IN}} = 3.3\text{V}$ for this test.

The load resistor is connected to the regulator output using a switch so that the load current increases from 0 to 6A abruptly. The change in output voltage is shown in the scope photo (the vertical scale is 50 mV/division and the horizontal scale is 20 μs /division. The regulator nominal output (1.5V) is located on the center line of the photo. A maximum change of about -80 mV is shown.

Reference Designs (Continued)

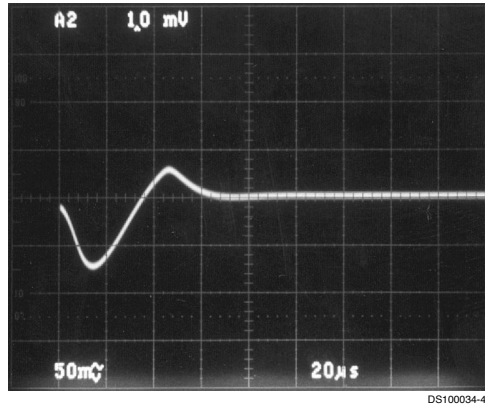

Transient Response for 0–6A Load Step

Application Hints

SELECTING THE FET

The best choice of FET for a specific application will depend on a number of factors:

VOLTAGE RATING: The FET must have a Drain-to-Source breakdown voltage (sometimes called BV_{DSS}) which is greater than the input voltage.

DRAIN CURRENT: On-state Drain current must be specified to be greater than the worst-case (short circuit) load current for the application.

TURN-ON THRESHOLD: The Gate-to-Source voltage where the FET turns on (called the Gate Threshold Voltage) is very important. Many FET's are intended for use with G-to-S voltages in the 5V to 10V range. These should only be used in applications where the input voltage is high enough to provide >5V of drive to the Gate.

Newer FET's are becoming available with lower turn-on thresholds (Logic-Level FET's) which turn on fully with a gate voltage of only 3V to 4V. Low threshold FET's should be used in applications where the input voltage is $\leq 5V$.

ON RESISTANCE: FET on resistance (often called $R_{DS(ON)}$) is a critical parameter since it directly determines the minimum input-to-output voltage required for operation at a given load current (also called **dropout voltage**).

$R_{DS(ON)}$ is highly dependent on the amount of Gate-to-Source voltage applied. For example, the $R_{DS(ON)}$ of a FET with $V_{G-S} = 5V$ will typically decrease by about 25% as the V_{G-S} is increased to 10V. $R_{DS(ON)}$ is also temperature dependent, increasing at higher temperatures.

The dropout voltage of any LDO design is directly related to $R_{DS(ON)}$, as given by:

$$V_{DROPOUT} = I_{LOAD} \times (R_{DS(ON)} + R_{SC})$$

Where R_{SC} is the short-circuit current limit set resistor (see Application Circuit).

GATE CAPACITANCE: Selecting a FET with the lowest possible Gate capacitance improves LDO performance in two ways:

1) The Gate pin of the LP2975 (which drives the Gate of the FET) has a limited amount of current to source or sink. This

means faster changes in Gate voltage (which corresponds to faster transient response) will occur with a smaller amount of Gate capacitance.

2) The Gate capacitance forms a pole in the loop gain which can reduce phase margin. When possible, this pole should be kept at a higher frequency than the cross-over frequency of the regulator loop (see later section *CROSS-OVER FREQUENCY AND PHASE MARGIN*).

A high value of Gate capacitance may require that a feedforward capacitor be used to cancel some of the excess phase shift (see later section *FEED-FORWARD CAPACITOR*) to prevent loop instability.

POWER DISSIPATION: The maximum power dissipated in the FET in any application can be calculated from:

$$P_{MAX} = (V_{IN} - V_{OUT}) \times I_{MAX}$$

Where the term I_{MAX} is the maximum output current. It should be noted that if the regulator is to be designed to withstand short-circuit, a current sense resistor must be used to limit I_{MAX} to a safe value (refer to section *SHORT-CIRCUIT CURRENT LIMITING*).

The power dissipated in the FET determines the best choice for package type. A TO-220 package device is best suited for applications where power dissipation is less than 15W. Power levels above 15W would almost certainly require a TO-3 type device.

In low power applications, surface-mount package devices are size-efficient and cost-effective, but care must be taken to not exceed their power dissipation limits.

POWER DISSIPATION AND HEATSINKING

Since the LP2975 controller is suitable for use with almost any external P-FET, it follows that designs can be built which have very high power dissipation in the pass FET. Since the controller can not protect the FET from overtemperature damage, thermal design must be carefully done to assure a reliable design.

THERMAL DESIGN METHOD: The temperature of the FET and the power dissipated is defined by the equation:

$$T_J = (\theta_{J-A} \times P_D) + T_A$$

Where:

T_J is the **junction temperature of the FET**.

T_A is the **ambient temperature**.

P_D is the **power dissipated by the FET**.

θ_{J-A} is the **junction-to-ambient thermal resistance**.

To ensure a reliable design, the following guidelines are recommended:

- 1) Design for a maximum (worst-case) FET junction temperature which does not exceed 150°C.
- 2) Heatsinking should be designed for worst-case (maximum) values of T_A and P_D .
- 3) In designs which must survive a short circuit on the output, the maximum power dissipation must be calculated assuming that the output is shorted to ground:

$$P_D(MAX) = V_{IN} \times I_{SC}$$

Where I_{SC} is the **short-circuit output current**.

4) If the design is not intended to be short-circuit proof, the maximum power dissipation for intended operation will be:

$$P_D(MAX) = (V_{IN} - V_{OUT}) \times I_{MAX}$$

Where I_{MAX} is the **maximum output current**.

LOW POWER (<2W) APPLICATIONS: In most cases, some type of small surface-mount device will be used for the

Application Hints (Continued)

FET in low power designs. Because of the increased cell density (and tiny packages) used by modern FET's, the current carrying capability may easily exceed the power dissipation limits of the package. It is possible to parallel two or more FET's, which divides the power dissipation among all of the packages.

It should be noted that the "heatsink" for a surface mount package is the copper of the PC board and the package itself (direct radiation).

Surface-mount devices have the value of θ_{J-A} specified for a typical PC board mounting on their data sheet. In most cases it is best to start with the known data for the application (P_D , T_A , T_J) and calculate the required value of θ_{J-A} needed. This value will define the type of FET and, possibly, the heatsink required for cooling.

$$\theta_{J-A} = (T_J - T_A) / P_D(\text{MAX})$$

DESIGN EXAMPLE: A design is to be done with $V_{IN} = 5V$ and $V_{OUT} = 3.3V$ with a maximum load current of 300 mA. Based on these conditions, power dissipation in the FET during normal operation would be:

$$P_D = (V_{IN} - V_{OUT}) \times I_{LOAD}$$

Solving, we find that $P_D = 0.51W$. Assuming that the maximum allowable value of T_J is $150^\circ C$ and the maximum T_A is $70^\circ C$, the value of θ_{J-A} is found to be **157°C/W**.

However, if this design must survive a continuous short on the output, the power dissipated in the FET is higher:

$$P_D(\text{SC}) = V_{IN} \times I_{SC} = 5 \times 0.33 = \mathbf{1.65W}$$

(This assumes the current sense resistor is selected for an I_{SC} value that is 10% higher than the required 0.3A).

The value of θ_{J-A} required to survive continuous short circuit is calculated to be **49°C/W**.

Having solved for the value(s) of θ_{J-A} , a FET can be selected. It should be noted that a FET must be used with a θ_{J-A} value less than or equal to the calculated value.

HIGH POWER ($\geq 2W$) APPLICATIONS: As power dissipation increases above 2W, a FET in a larger package must be used to obtain lower values of θ_{J-A} . The same formulae derived in the previous section are used to calculate P_D and θ_{J-A} .

Having found θ_{J-A} , it becomes necessary to calculate the value of θ_{S-A} (the heatsink-to-ambient thermal resistance) so that a heatsink can be selected:

$$\theta_{S-A} = \theta_{J-A} - (\theta_{J-C} + \theta_{C-S})$$

Where:

θ_{J-C} is the **junction-to-case thermal resistance**. This parameter is the measure of thermal resistance between the semiconductor die inside the FET and the surface of the case of the FET where it mounts to the heatsink (the value of θ_{J-C} can be found on the data sheet for the FET). A typical FET in a TO-220 package will have a θ_{J-C} value of approximately $2-4^\circ C/W$, while a device in a TO-3 package will be about $0.5-2^\circ C/W$.

θ_{C-S} is the **case-to-heatsink thermal resistance**, which measures how much thermal resistance exists between the surface of the FET and the heatsink. θ_{C-S} is dependent on the package type and mounting method. A TO-220 package with mica insulator and mounting grease secured to a heatsink will have a θ_{C-S} value in the range of $1-1.5^\circ C/W$. A TO-3 package mounted in the same manner will have a θ_{C-S} value

of $0.3-0.5^\circ C/W$. The best source of information for this is heatsink catalogs (Wakefield, AAVID, Thermalloy) since they also sell mounting hardware.

θ_{S-A} is the **heatsink-to-ambient thermal resistance**, which defines how well a heatsink transfers heat into the air. Once this is determined, a heatsink must be selected which has a value which is less than or equal to the computed value. The value of θ_{S-A} is usually listed in the manufacturer's data sheet for a heatsink, but the information is sometimes given in a graph of temperature rise vs. dissipated power.

DESIGN EXAMPLE: A design is to be done which takes 3.3V in and provides 2.5V out at a load current of 7A. The power dissipation will be calculated for both normal operation and short circuit conditions.

For normal operation:

$$P_D = (V_{IN} - V_{OUT}) \times I_{LOAD} = \mathbf{5.6W}$$

If the output is shorted to ground:

$$P_D(\text{SC}) = V_{IN} \times I_{SC} = 3.3 \times 7.7 = \mathbf{25.4W}$$

(Assuming that a sense resistor is selected to set the value of I_{SC} 10% above the nominal 7A).

θ_{J-A} will be calculated assuming a maximum T_A of $70^\circ C$ and a maximum T_J of $150^\circ C$:

$$\theta_{J-A} = (T_J - T_A) / P_D(\text{MAX})$$

For normal operation:

$$\theta_{J-A} = (150 - 70) / 5.6 = \mathbf{14.3^\circ C/W}$$

For designs which must operate with the output shorted to ground:

$$\theta_{J-A} = (150 - 70) / 25.4 = \mathbf{3.2^\circ C/W}$$

The value of $14.3^\circ C/W$ can be easily met using a TO-220 device. Calculating the value of θ_{S-A} required (assuming a value of $\theta_{J-C} = 3^\circ C/W$ and $\theta_{C-S} = 1^\circ C/W$):

$$\theta_{S-A} = \theta_{J-A} - (\theta_{J-C} + \theta_{C-S})$$

$$\theta_{S-A} = 14.3 - (3 + 1) = \mathbf{10.3^\circ C/W}$$

Any heatsink may be used with a thermal resistance $\leq 10.3^\circ C/W$ @ 5.6W power dissipation (refer to manufacturer's data sheet curves). Examples of suitable heatsinks are Thermalloy #6100B and IERC #LATO127B5CB.

However, if the design must survive a sustained short on the output, the calculated θ_{J-A} value of $3.2^\circ C/W$ eliminates the possibility of using a TO-220 package device.

Assuming a TO-3 device is selected with a θ_{J-C} value of $1.5^\circ C/W$ and $\theta_{C-S} = 0.4^\circ C/W$, we can calculate the required value of θ_{S-A} :

$$\theta_{S-A} = \theta_{J-A} - (\theta_{J-C} + \theta_{C-S})$$

$$\theta_{S-A} = 3.2 - (1.5 + 0.4) = \mathbf{1.3^\circ C/W}$$

A θ_{S-A} value $\leq 1.3^\circ C/W$ would require a relatively large heatsink, or possibly some kind of forced airflow for cooling.

SHORT-CIRCUIT CURRENT LIMITING

Short-circuit current limiting is easily implemented using a single external resistor (R_{SC}). The value of R_{SC} can be calculated from:

$$R_{SC} = V_{CL} / I_{SC}$$

Where:

I_{SC} is the desired **short circuit current**.

V_{CL} is the **current limit sense voltage**.

The value of V_{CL} is 57 mV (typical), with guaranteed limits listed in the Electrical Characteristics section. When doing a worst-case calculation for power dissipation in the FET, it is important to consider both the tolerance of V_{CL} and the tolerance (and temperature drift) of R_{SC} .

Application Hints (Continued)

For maximum accuracy, the *INPUT* and *CURRENT LIMIT* pins must be Kelvin connected to R_{SC} , to avoid errors caused by voltage drops along the traces carrying the current from the input supply to the *Source* pin of the FET.

EXTERNAL CAPACITORS

The best capacitors for use in a specific design will depend on voltage and load current (examples of tested circuits for several different output voltages and currents are provided in a previous section.)

Information in the next sections is provided to aid the designer in the selection of the external capacitors.

INPUT CAPACITOR: Although not always required, an input capacitor is recommended. Good bypassing on the input assures that the regulator is working from a source with a low impedance, which improves stability. A good input capacitor can also improve transient response by providing a reservoir of stored energy that the regulator can utilize in cases where the load current demand suddenly increases. The value used for C_{IN} may be increased without limit. Refer to the Reference Designs section for examples of input capacitors.

OUTPUT CAPACITOR: The output capacitor is required for loop stability (compensation) as well as transient response. During sudden changes in load current demand, the output capacitor must source or sink current during the time it takes the control loop of the LP2975 to adjust the gate drive to the pass FET. As a general rule, a larger output capacitor will improve both transient response and phase margin (stability). The value of C_{OUT} may be increased without limit.

OUTPUT CAPACITOR AND COMPENSATION: Loop compensation for the LP2975 is derived from C_{OUT} and, in some cases, the feed-forward capacitor C_F (see next section).

C_{OUT} forms a pole (referred to as f_p) in conjunction with the load resistance which causes the loop gain to roll off (decrease) at an additional -20 dB/decade. The frequency of the pole is:

$$f_p = 0.16 / [(R_L + ESR) \times C_{OUT}]$$

Where:

R_L is the **load resistance**.

C_{OUT} is the **value of the output capacitor**.

ESR is the **equivalent series resistance of C_{OUT}** .

As a general guideline, the frequency of f_p should be ≤ 200 Hz. It should be noted that higher load currents correspond to lower values of R_L , which requires that C_{OUT} be increased to keep f_p at a given frequency.

DESIGN EXAMPLE: Select the minimum required output capacitance for a design whose output specifications are 5V @ 1A:

$$f_p = 0.16 / [(R_L + ESR) \times C_{OUT}]$$

Re-written:

$$C_{OUT} = 0.16 / [f_p \times (R_L + ESR)]$$

Values used for the calculation:

$f_p = 200$ Hz, $R_L = 5\Omega$, $ESR = 0.1\Omega$ (assumed).

Solving for C_{OUT} , we get **157 μ F** (nearest standard size would be 180 μ F).

The ESR of the output capacitor is very important for stability, as it creates a zero (f_z) which cancels much of the phase shift resulting from one of the poles present in the loop. The frequency of the zero is calculated from:

$$f_z = 0.16 / (ESR \times C_{OUT})$$

For best results in most designs, the frequency of f_z should fall between 5 kHz and 50 kHz. It must be noted that the values of C_{OUT} and ESR usually vary with temperature (severely in the case of aluminum electrolytics), and this must be taken into consideration.

For the design example ($V_{OUT} = 5V @ 1A$), select a capacitor which meets the f_z requirements. Solving the equation for ESR yields:

$$ESR = 0.16 / (f_z \times C_{OUT})$$

Assuming $f_z = 5$ kHz and 50 kHz, the limiting values of ESR for the 180 μ F capacitor are found to be:

$$18 \text{ m}\Omega \leq ESR \leq 0.18\Omega$$

A good-quality, low-ESR capacitor type such as the Panasonic HFQ is a good choice. However, the 10V/180 μ F capacitor (#ECA-1AFQ181) has an ESR of 0.3 Ω which is not in the desired range.

To assure a stable design, some of the options are:

1) Use a different type capacitor which has a lower ESR such as an organic-electrolyte OSCON.

2) Use a higher voltage capacitor. Since ESR is inversely proportional to the physical size of the capacitor, a higher voltage capacitor with the same C value will typically have a lower ESR (because of the larger case size). In this example, a Panasonic ECA-1EFQ181 (which is a 180 μ F/25V part) has an ESR of 0.17 Ω and would meet the desired ESR range.

3) Use a feed-forward capacitor (see next section).

FEED-FORWARD CAPACITOR: Although not required in every application, the use of a feed-forward capacitor (C_F) can yield improvements in both phase margin and transient response in most designs.

The added phase margin provided by C_F can prevent oscillations in cases where the required value of C_{OUT} and ESR can not be easily obtained (see previous section).

C_F can also reduce the phase shift due to the pole resulting from the Gate capacitance, stabilizing applications where this pole occurs at a low frequency (before cross-over) which would cause oscillations if left uncompensated (see later section *GATE CAPACITANCE POLE FREQUENCY*).

Even in a stable design, adding C_F will typically provide more optimal loop response (faster settling time). For these reasons, **the use of a feed-forward capacitor is always recommended.**

C_F is connected across the top resistor in the divider used to set the output voltage (see Typical Application Circuit). This forms a zero in the loop response (defined as f_{zf}), whose frequency is:

$$f_{zf} = 6.6 \times 10^{-6} / [C_F \times (V_{OUT} / 1.24 - 1)]$$

When solved for C_F , the f_{zf} equation is:

$$C_F = 6.6 \times 10^{-6} / [f_{zf} \times (V_{OUT} / 1.24 - 1)]$$

For most applications, f_{zf} should be set between 5 kHz and 50 kHz.

ADJUSTING THE OUTPUT VOLTAGE

If an output voltage is required which is not available as a standard voltage, the LP2975 can be used as an adjustable regulator (see Typical Application circuit). The external resistors $R1$ and $R2$ (along with the internal 24 k Ω resistor) set the output voltage.

It is important to note that $R2$ is connected in parallel with the internal 24 k Ω resistor. If we define R_{EQ} as the **total resistance between the COMP pin and ground**, then its value will be the parallel combination of $R2$ and 24 k Ω :

Application Hints (Continued)

$$R_{EQ} = (R2 \times 24k) / (R2 + 24k)$$

It follows that the output voltage will be:

$$V_{OUT} = 1.24 [(R1 / R_{EQ}) + 1]$$

Some important considerations for an adjustable design:

The tolerance of the internal 24 kΩ resistor is about ±20%. Also, its temperature coefficient is almost certainly different than the TC of the external resistor that is used for R2.

For these reasons, it is recommended that R2 be set at a value that is not greater than 1.2k. In this way, the value of R2 will dominate R_{EQ} , and the tolerance and TC of the internal 24k resistor will have a negligible effect on output voltage accuracy.

To determine the value for R1:

$$R1 = R_{EQ} [(V_{OUT} / 1.24) - 1]$$

External Capacitors (Adjustable Application)

All information in the previous section *EXTERNAL CAPACITORS* applies to the adjustable application with the exception of how to select the value of the feed-forward capacitor.

The feed-forward capacitor C_C in the adjustable application (see Typical Application Circuit) performs exactly the same function as described in the previous section *FEEDFORWARD CAPACITOR*. However, because R1 is user-selected, a different formula must be used to determine the value of C_C :

$$C_C = 1 / (2 \pi \times R1 \times f_{zf})$$

As stated previously, the optimal frequency at which to place the zero f_{zf} is usually between 5 kHz and 50 kHz.

OPTIMIZING DESIGN STABILITY

Because the LP2975 can be used with a variety of different applications, there is no single set of components that are best suited to every design. This section provides information which will enable the designer to select components that optimize stability (phase margin) for a specific application.

Gate Capacitance

An important consideration of a design is to identify the frequency of the pole which results from the capacitance of the Gate of the FET (this pole will be referred to as f_{pg}). As f_{pg} gets closer to the loop crossover frequency, the phase margin is reduced. Information will now be provided to allow the total Gate capacitance to be calculated so that f_{pg} can be approximated.

The first step in calculating f_p is to determine how much **effective Gate capacitance (C_{EFF})** is present. The formula for calculating C_{EFF} is:

$$C_{EFF} = C_{GS} + C_{GD} [1 + G_m (R_L // ESR)]$$

Where:

C_{GS} is the **Gate-to-Source capacitance**, which is found from the values (refer to FET data sheet for values of C_{ISS} and C_{RSS}):

$$C_{GS} = C_{ISS} - C_{RSS}$$

C_{GD} is the **Gate-to-Drain capacitance**, which is equal to:

$$C_{GD} = C_{RSS}$$

G_m is the **transconductance of the FET**. The FET data sheet specifies forward transconductance (G_{fs}) at some value of drain current (defined as I_D). To find G_m at the desired value of load current (defined as I_L), use the formula:

$$G_m = G_{fs} \times (I_L / I_D)^{1/2}$$

Where:

R_L is the **load resistance**.

ESR is the **equivalent series resistance** of the output capacitor.

The term $R_L // ESR$ is defined as:

$$(R_L \times ESR) / (R_L + ESR)$$

It can be seen from these equations that C_{EFF} varies with R_L . To get the worst-case (maximum) value for C_{EFF} , use the maximum value of load current, which also means the minimum value of load resistance R_L . It should be noted that in most cases, the ESR is the dominant term which determines the value of $R_L // ESR$.

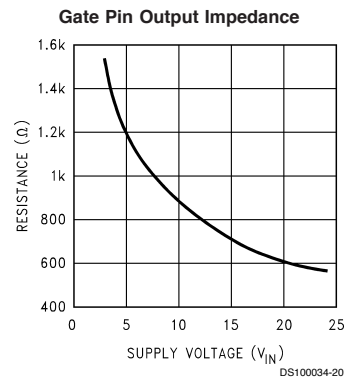

Gate Capacitance Pole Frequency (f_{pg})

The pole frequency resulting from the Gate capacitance C_{EFF} is defined as f_{pg} and can be approximated from:

$$f_{pg} \approx 0.16 / (R_O \times C_{EFF})$$

Where:

R_O is the **output impedance of the LP2975 Gate pin** which drives the Gate of the FET. It is important to note that R_O is a function of input supply voltage (see graph *GATE PIN OUTPUT IMPEDANCE*). As shown, the minimum value of R_O is about 550Ω @ $V_{IN} = 24V$, increasing to about 1.55 kΩ @ $V_{IN} = 3V$.

Using the equation for f_{pg} , a family of curves are provided showing how f_{pg} varies with C_{EFF} for several values of R_O (see graph f_{pg} vs. C_{EFF}):

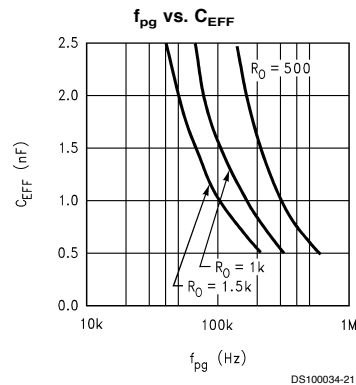

Application Hints (Continued)

As can be seen in the graph, values of C_{EFF} in the 500 pF–2500 pF range produce values for f_{pg} between 40 kHz and 700 kHz. To determine what effect f_{pg} will have on stability, the bandwidth of the regulator loop must be calculated (see next section *CROSSOVER FREQUENCY AND PHASE MARGIN*).

Crossover Frequency and Phase Margin

The term f_c will be used to define the crossover frequency of the regulator loop (which is the frequency where the gain curve crosses the 0 dB axis). The importance of this frequency is that it is the point where the loop gain goes below unity, which marks the usable bandwidth of the regulator loop.

It is the **phase margin** (or lack of it) at f_c that determines whether the regulator is stable. Phase margin is defined as the total phase shift subtracted from 180° . In general, a stable loop requires at least 20° – 30° of phase margin at f_c .

f_c can be approximated by the following equation (all terms have been previously defined):

$$f_c \approx \frac{[3 \times 10^5 \times G_m \times (1.24/V_0)]^{1/2}}{[2 \times \pi \times C_{OUT}]^{1/2}}$$

DS100034-23

This equation assumes that no C_F is used and $f_{pg}/f_c > 1$.

If the frequency of the Gate capacitance pole f_{pg} has been calculated (previous section), the amount of added phase shift may now be determined. As shown in the graph below (see graph *PHASE SHIFT DUE TO f_{pg}*), the amount of added phase shift increases as f_{pg} approaches f_c .

The amount of phase shift due to f_{pg} that can occur before oscillation takes place depends on how much added phase shift is present as a result of the C_{OUT} pole (see previous section *OUTPUT CAPACITOR*).

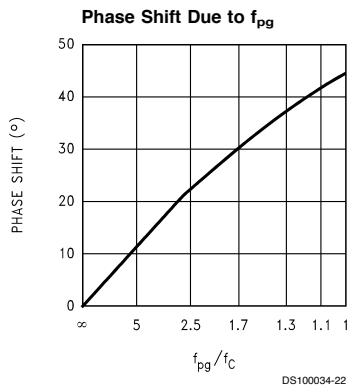

Because of this, there is no exact number for f_{pg}/f_c that can be given as a fixed limit for stable operation. However, as a general guideline, it is recommended that $f_{pg} \geq 3 f_c$.

If this is not found to be true after initial calculations, the ratio of f_{pg}/f_c can be increased by either reducing C_{EFF} (selecting a different FET) or using a larger value of C_{OUT} .

Along with these two methods, another technique for improving loop stability is the use of a feed-forward capacitor (see

next section *FEED-FORWARD COMPENSATION*). This can improve phase margin by cancelling some of the excess phase shift.

Feed-Forward Compensation

Phase shift in the loop gain of the regulator results from f_p (the pole from the output capacitor and load resistance), f_{pg} (the pole from the FET gate capacitance), as well as the IC's internal controller pole (see typical curve). If the total phase shift becomes excessive, instability can result.

The total phase shift can be reduced using feed-forward compensation, which places a zero in the loop to reduce the effects of the poles.

The feed-forward capacitor C_F can accomplish this, provided it is selected to set the zero at the correct frequency. It is important to point out that the feed-forward capacitor produces *both a zero and a pole*. The frequency where the zero occurs will be defined as f_{zf} , and the frequency of the pole will be defined as f_{pf} . The equations to calculate the frequencies are:

$$f_{zf} = 6.6 \times 10^{-6} / [C_F \times (V_{OUT}/1.24 - 1)]$$

$$f_{pf} = 6.6 \times 10^{-6} / [C_F \times (1 - 1.24/V_{OUT})]$$

In general, the feed-forward capacitor gives the greatest improvement in phase margin (provides the maximum reduction in phase shift) when the zero occurs at a frequency where the loop gain is >1 (before the crossover frequency). The pole must occur at a higher frequency (the higher the better) where most of the phase shift added by the new pole occurs beyond the crossover frequency. For this reason, the pole-zero pair created by C_F become more effective at improving loop stability as they get farther apart in frequency.

In reviewing the equations for f_{zf} and f_{pf} , it can be seen that they get closer together in frequency as V_{OUT} decreases. For this reason, the use of C_F gives greatest benefit at higher output voltages, declining as V_{OUT} approaches 1.24V (where C_F has no effect at all).

In selecting a value of feed-forward capacitor, the crossover frequency f_c must first be calculated. In general, the frequency of the zero (f_{zf}) set by this capacitor should be in the range:

$$0.2 f_c \leq f_{zf} \leq 1.0 f_c$$

The equation to determine the value of the feed-forward capacitor in fixed-voltage applications is:

$$C_F = 6.6 \times 10^{-6} / [f_{zf} \times (V_{OUT}/1.24 - 1)]$$

In adjustable applications (using an external resistive divider) the capacitor is found using:

$$C_C = 1/(2 \pi \times R1 \times f_{zf})$$

SUMMARY OF STABILITY INFORMATION

This section will present an explanation of theory and terminology used to analyze loop stability, along with specific information related to stabilizing LP2975 applications.

BODE PLOTS AND PHASE SHIFT

Loop gain information is most often presented in the form of a **Bode Plot**, which plots **Gain** (in dB) versus **Frequency** (in Hertz).

A Bode Plot also conveys phase shift information, which can be derived from the locations of the **poles** and **zeros**.

POLE: A pole causes the slope of the gain curve to **decrease by an additional -20 dB/decade**, and it also causes **phase lag** (defined as **negative phase shift**) to occur.

A single pole will cause a maximum -90° of phase lag (see graph *EFFECTS OF A SINGLE POLE*). It should be noted

Application Hints (Continued)

that when the total phase shift at 0 dB reaches (or gets close to) -180° , oscillations will result. Therefore, it can be seen that at least **two poles** in the gain curve are required to cause instability.

ZERO: A zero has an effect that is exactly *opposite to a pole*. A zero will add a maximum $+90^\circ$ of **phase lead** (defined as **positive phase shift**). Also, a zero causes the slope of the gain curve to **increase** by an additional $+20$ dB/decade (see graph *EFFECTS OF A SINGLE ZERO*).

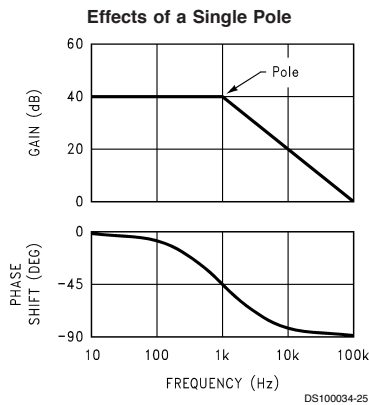

TOTAL PHASE SHIFT: The actual test of whether or not a regulator is stable is the amount of phase shift that is present when the gain curve crosses the 0 dB axis (the frequency where this occurs was previously defined as f_c).

The phase shift at f_c can be estimated by looking at all of the poles and zeroes on the Bode plot and adding up the contributions of phase lag and lead from each one. As shown in the graphs, most of the phase lag (or lead) contributed by a pole (or zero) occurs within one decade of the frequency of the pole (or zero).

In general, a **phase margin** (defined as the difference between the total phase shift and -180°) of at least 20° to 30° is required for a stable loop.

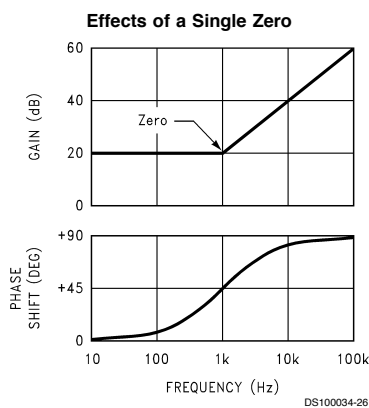

STABILITY ANALYSIS OF TYPICAL APPLICATIONS

The first application to be analyzed is a fixed-output voltage regulator with no feed-forward capacitor (see graph *STABLE PLOT WITHOUT FEED-FORWARD*).

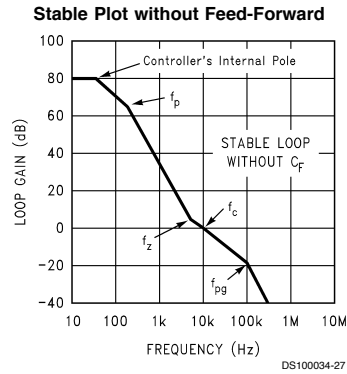

In this example, the value of C_{OUT} is selected so that the pole formed by C_{OUT} and R_L (previously defined as f_p) is set at 200 Hz. The ESR of C_{OUT} is selected so that zero formed by the ESR and C_{OUT} (defined as f_z) is set at 5 kHz (these selections follow the general guidelines stated previously in this document). Note that the gate capacitance is assumed to be moderate, with the pole formed by the C_{GATE} (defined as f_{pg}) occurring at 100 kHz.

To estimate the total phase margin, the individual phase shift contributions of each pole and zero will be calculated assuming $f_p = 200$ Hz, $f_z = 5$ kHz, $f_c = 10$ kHz and $f_{pg} = 100$ kHz:

Controller pole shift = -90°

f_p shift = $-\arctan(10k/200) = -89^\circ$

f_z shift = $\arctan(10k/5k) = +63^\circ$

f_{pg} shift = $-\arctan(10k/100k) = -6^\circ$

Summing the four numbers, the estimate for the **total phase shift is -122°** , which corresponds to a **phase margin of 58°** .

This application is stable, but could be improved by using a feed-forward capacitor (see next section).

EFFECT OF FEED-FORWARD: The example previously used will be continued with the addition of a feed-forward capacitor C_F (see graph *IMPROVED PHASE MARGIN WITH FEED-FORWARD*). The zero formed by C_F (previously defined as f_{zf}) is set at 10 kHz and the pole formed by C_F (previously defined as f_{pf}) is set at 40 kHz (the 4X ratio of f_{pf}/f_{zf} corresponds to $V_{OUT} = 5V$).

Application Hints (Continued)

Improved Phase Margin with Feed-Forward

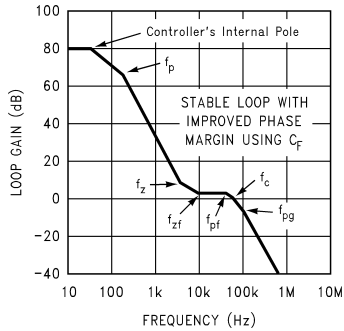

To estimate the total phase margin, the individual phase shift contributions of each pole and zero will be calculated assuming $f_p = 200$ Hz, $f_z = 5$ kHz, $f_{zf} = 10$ kHz, $f_{pf} = 40$ kHz, $f_c = 50$ kHz, and $f_{pg} = 100$ kHz:

Controller pole shift = -90°

f_p shift = $-\arctan(50k/200) = -90^\circ$

f_z shift = $\arctan(50k/5k) = +84^\circ$

f_{zf} shift = $\arctan(50k/10k) = +79^\circ$

f_{pf} shift = $-\arctan(50k/40k) = -51^\circ$

f_{pg} shift = $-\arctan(50k/100k) = -27^\circ$

Summing the six numbers, the estimate for the **total phase shift is -95°** , which corresponds to a **phase margin of 85°** (a 27° improvement over the same application without the feed-forward capacitor).

For this reason, a feed-forward capacitor is recommended in all applications. Although not always required, the added phase margin typically gives faster settling times and provides some design guard band against C_{OUT} and ESR variations with temperature.

CAUSES AND CURES OF OSCILLATIONS

The most common cause of oscillations in an LDO application is the output capacitor ESR. If the ESR is too high or too low, the zero (f_z) does not provide enough phase lead.

HIGH ESR: To illustrate the effect of an output capacitor with high ESR, the previous example will be repeated except that the ESR will be **increased** by a factor of 20X. This will cause the frequency of the zero f_z to **decrease** by 20X, which moves it from 5 kHz down to 250 Hz (see graph **HIGH ESR UNSTABLE WITHOUT FEED-FORWARD**).

High ESR Unstable without Feed-Forward

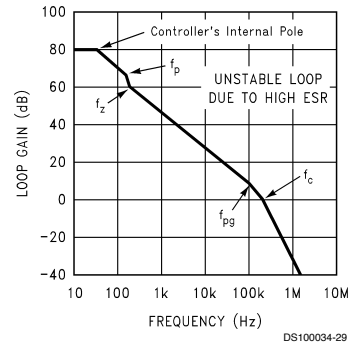

As shown, moving the location of f_z lower in frequency extends the bandwidth, pushing the crossover frequency f_c out to about 200 kHz. In viewing the plot, it can be seen that f_p and f_z essentially cancel out, leaving only the controller pole and f_{pg} . However, since f_{pg} now occurs well before f_c , it will cause enough phase shift to leave very little phase margin. This application would either oscillate continuously or be marginally stable (meaning it would exhibit severe ringing on transient steps).

This can be improved by adding a feed-forward capacitor C_F , which adds a zero (f_{zf}) and a pole (f_{pf}) to the gain plot (see graph **HIGH ESR CORRECTED WITH FEED-FORWARD**).

In this case, C_F is selected to place f_{zf} at about the same frequency as f_{pg} (essentially cancelling out the phase shift due to f_{pg}). Assuming the added pole f_{pf} is near or beyond the f_c frequency, it will add $< 45^\circ$ of phase lag, leaving a phase margin of $> 45^\circ$ (adequate for good stability).

High ESR Corrected with Feed-Forward

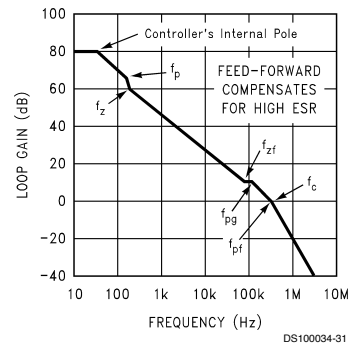

LOW ESR: To illustrate how an output capacitor with low ESR can cause an LDO regulator to oscillate, the same example will be shown except that the ESR will be reduced sufficiently to increase the original f_z from 5 kHz to 50 kHz.

The plot now shows (see graph **LOW ESR UNSTABLE WITHOUT FEED-FORWARD**) that the crossover frequency f_c has moved down to about 8 kHz. Since f_z is 6X f_c , it means that the zero f_z can only provide about 9° of phase lead at f_c , which is not sufficient for stability.

Application Hints (Continued)

Low ESR Unstable without Feed-Forward

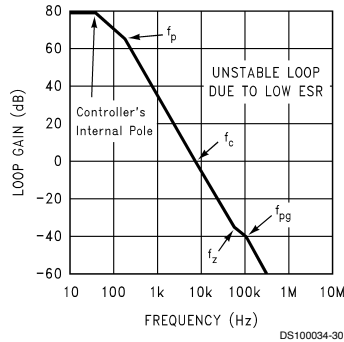

This application can also be improved by adding a feed-forward capacitor. C_F will add both a zero f_{zf} and pole f_{pf} to the gain plot (see graph *LOW ESR CORRECTED WITH FEED-FORWARD*).

The crossover frequency f_c is now about 10 kHz. If C_F is selected so that f_{zf} is about 5 kHz, and f_{pf} is about 20 kHz (which means $V_{OUT} = 5V$), the phase margin will be considerably improved. Calculating out all the poles and zeroes, the phase margin is increased from 9° to 43° (adequate for good stability).

Low ESR Corrected with Feed-Forward

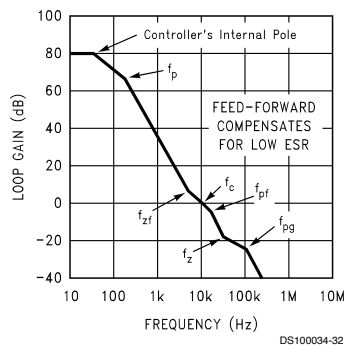

EXCESSIVE GATE CAPACITANCE: Higher values of gate capacitance shift the pole f_{pg} to lower frequencies, which can cause stability problems (see previous section *GATE CAPACITANCE POLE FREQUENCY*). As shown in the graph f_{pg} vs. C_{EFF} , the pole f_{pg} will likely fall somewhere between 40 kHz and 500 kHz. How much phase shift this adds depends on the crossover frequency f_c .

The effect of gate capacitance becomes most important at high values of ESR for the output capacitor (see graph *HIGH ESR UNSTABLE WITHOUT FEED-FORWARD*). Higher values of ESR increase f_c , which brings f_{pg} more into the positive gain portion of the curve. As f_{pg} moves to a lower frequency (corresponding to higher values of gate capacitance), this effect becomes even worse.

This points out why FET's should be selected with the lowest possible gate capacitance: it makes the design more tolerant of higher ESR values on the output capacitor.

The use of a feed-forward capacitor C_F will help reduce excess phase shift due to f_{pg} , but its effectiveness depends on output voltage (see next section).

LOW OUTPUT VOLTAGE AND C_F

The feed-forward capacitor C_F will provide a positive phase shift (lead) which can be used to cancel some of the excess phase lag from any of the various poles present in the loop. However, it is important to note that the effectiveness of C_F decreases with output voltage.

This is due to the fact that the frequencies of the zero f_{zf} and pole f_{pf} get closer together as the output voltage is reduced (see equations in section *FEED-FORWARD COMPENSATION*).

C_F is more effective when the pole-zero pair are farther apart, because there is less self cancellation. The net benefit in phase shift provided by C_F is the **difference** between the lead (positive phase shift) from f_{zf} and the lag (negative phase shift) from f_{pf} which is present at the crossover frequency f_c . As the pole and zero frequency approach each other, that difference diminishes to nothing.

The amount of phase lead at f_c provided by C_F depends both on the f_{zf}/f_{pf} ratio and the location of f_z with respect to f_c . To illustrate this more clearly, a graph is provided which shows how much phase lead can be obtained for $V_{OUT} = 12V$, $5V$, and $3.3V$ (see graph *PHASE LEAD PROVIDED BY C_F*).

Phase Lead Provided by C_F

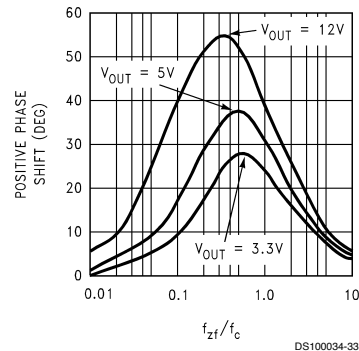

The most important information on the graph is the frequency range of f_{zf} which will provide the maximum benefit (most positive phase shift):

For $V_{OUT} = 12V$: $0.1 f_c < f_z < 1.0 f_c$

For $V_{OUT} = 5V$: $0.2 f_c < f_z < 1.2 f_c$

For $V_{OUT} = 3.3V$: $0.2 f_c < f_z < 1.3 f_c$

It's also important to note how the maximum available phase shift that C_F can provide drops off with V_{OUT} . At 12V, more than 50° can be obtained, but at 3.3V less than 30° is possible. The lesson from this is that higher voltage designs are more tolerant of phase shifts from both f_{pg} (the gate capacitance pole) and incorrect placement of f_z (which means the output capacitor ESR is not at its nominal value). At lower values of V_{OUT} , these parameters must be more precisely selected since C_F can not provide as much correction.

GENERAL DESIGN PROCEDURE

Assuming that V_{IN} , V_{OUT} , and R_L are defined:

Application Hints (Continued)

1) Calculate the required value of capacitance for C_{OUT} so that the pole $f_p \leq 200$ Hz (see previous section *OUTPUT CAPACITOR*). For this calculation, an ESR of about 0.1Ω can be assumed for the purpose of determining C_{OUT} .

IMPORTANT: If a smaller value of output capacitor is used (so that the value of $f_p > 200$ Hz), the phase margin of the control loop will be reduced. This will result in increased ringing on the output voltage during a load transient. If the output capacitor is made extremely small, oscillations will result.

To illustrate this effect, scope photos have been presented showing the output voltage of reference design #2 as the output capacitor is reduced to approximately 1/30 of the nominal value (the value which sets $f_p = 200$ Hz). As shown, the effect of deviating from the nominal value is gradual and the regulator is quite robust in resisting going into oscillations.

2) Approximate the crossover frequency f_c using the equation in the previous section *CROSSOVER FREQUENCY AND PHASE MARGIN*.

3) Calculate the required ESR of the output capacitor so that the frequency of the zero f_z is set to $0.5 f_c$ (see previous section *OUTPUT CAPACITOR*).

4) Calculate the value of the feed-forward capacitor C_F so that the zero f_{zf} occurs at the frequency which yields the

maximum phase gain for the output voltage selected (see previous section *LOW OUTPUT VOLTAGE AND C_F*). The formula for calculating C_F is in the previous section *FEED-FORWARD CAPACITOR*.

Lower ESR electrolytics are available which use organic electrolyte (OSCON types), but are more costly than typical aluminum electrolytics.

If the calculated value of ESR is higher than what is found in the selected capacitor, an external resistor can be placed in series with C_{OUT} .

LOW VOLTAGE DESIGNS: Designs which have a low output voltage (where the positive effects of C_F are very small) may be marginally stable if the C_{OUT} and ESR values are not carefully selected.

Also, if the FET gate capacitance is large (as in the case of a high-current FET), the pole f_{pg} could possibly get low enough in frequency to cause a problem.

The solution in both cases is to increase the amount of output capacitance which will shift f_p to a lower frequency (and reduce overall loop bandwidth). The ESR and C_F calculations should be repeated, since this changes the crossover frequency f_c .

Physical Dimensions inches (millimeters) unless otherwise noted

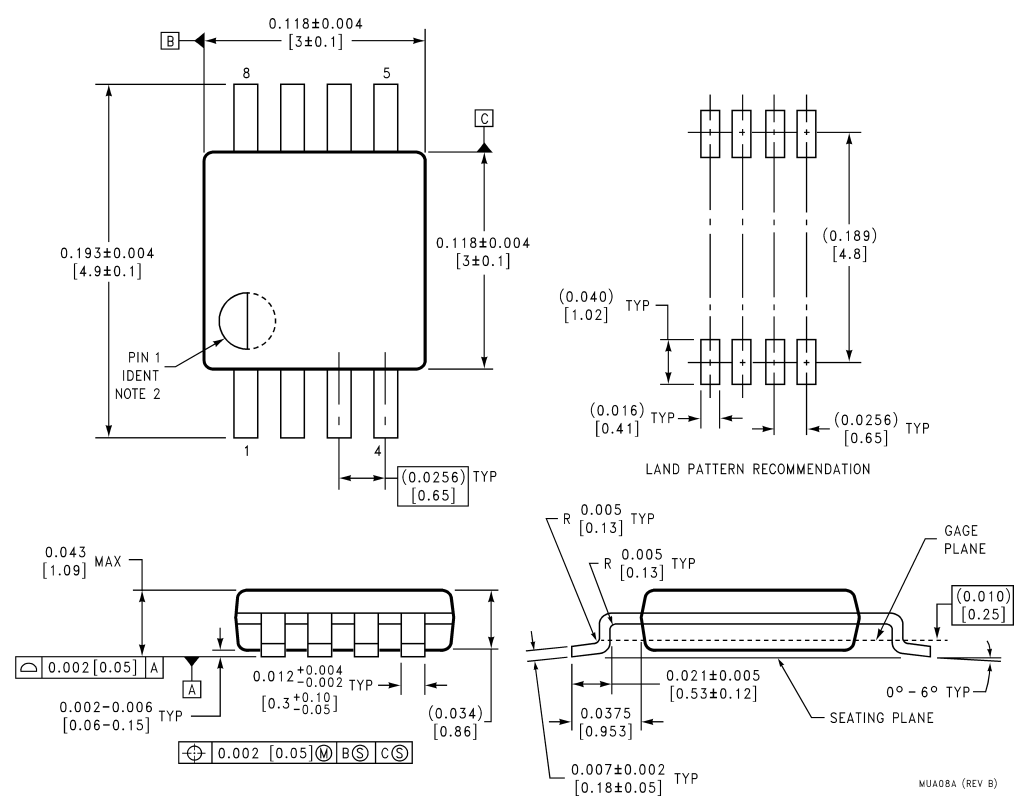

**Surface Mount Mini SO-8 Package
NS Package Number MUA08A**

LIFE SUPPORT POLICY

NATIONAL'S PRODUCTS ARE NOT AUTHORIZED FOR USE AS CRITICAL COMPONENTS IN LIFE SUPPORT DEVICES OR SYSTEMS WITHOUT THE EXPRESS WRITTEN APPROVAL OF THE PRESIDENT AND GENERAL COUNSEL OF NATIONAL SEMICONDUCTOR CORPORATION. As used herein:

1. Life support devices or systems are devices or systems which, (a) are intended for surgical implant into the body, or (b) support or sustain life, and whose failure to perform when properly used in accordance with instructions for use provided in the labeling, can be reasonably expected to result in a significant injury to the user.
2. A critical component is any component of a life support device or system whose failure to perform can be reasonably expected to cause the failure of the life support device or system, or to affect its safety or effectiveness.

 <p>National Semiconductor Corporation Americas Tel: 1-800-272-9959 Fax: 1-800-737-7018 Email: support@nsc.com www.national.com</p>	<p>National Semiconductor Europe Fax: +49 (0) 1 80-530 85 86 Email: europe.support@nsc.com Deutsch Tel: +49 (0) 1 80-530 85 85 English Tel: +49 (0) 1 80-532 78 32 Français Tel: +49 (0) 1 80-532 93 58 Italiano Tel: +49 (0) 1 80-534 16 80</p>	<p>National Semiconductor Asia Pacific Customer Response Group Tel: 65-2544466 Fax: 65-2504466 Email: sea.support@nsc.com</p>	<p>National Semiconductor Japan Ltd. Tel: 81-3-5639-7560 Fax: 81-3-5639-7507</p>
--	---	--	---

National does not assume any responsibility for use of any circuitry described, no circuit patent licenses are implied and National reserves the right at any time without notice to change said circuitry and specifications.