

BTA20/BTB20 Series

- **Description:**

High current density due to double mesa technology;
SIPOS and Glass Passivation.

- **Applications:**

BTA20/BTB20 series triacs is suitable for general purpose AC switching. They can be used as an ON/OFF function in applications such as static relays, heating regulation, induction motor starting circuits... or for phase control operation light dimmers, motor speed controllers.

- **Features:**

BTA20/BTB20-XXXSW/CW/BW are 3 Quadrants TRIACS, They are specially recommended for use on inductive loads. BTA16 are isolated internally, they provide a 2500V RMS isolation voltage from all three terminals to external heatsink. Blocking voltage to 600/1200V
On-state RMS current to 20A
Non-repetitive peak on-state current to 200A

- **Absolute Maximum Ratings**

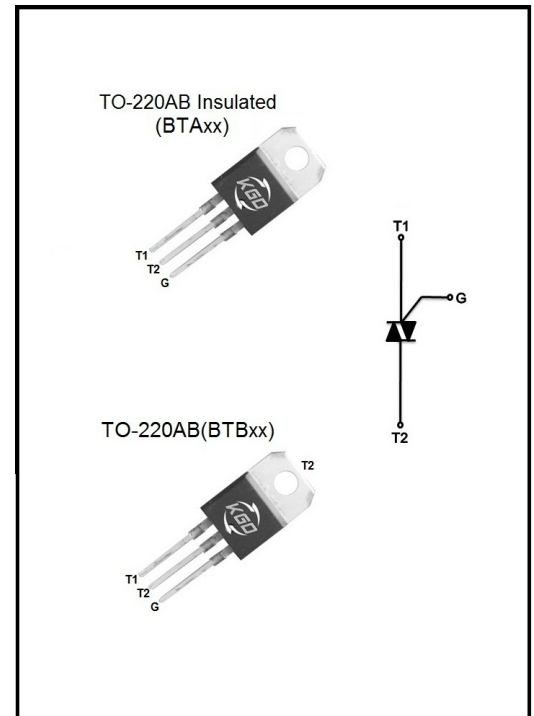

Symbol	Parameter	Conditions	Min	Max	Unit
V_{DRM}	Repetitive peak off-state voltage	$T_J=25^{\circ}C$	600	1200	V
V_{RRM}	Repetitive peak Reverse voltage	$T_J=25^{\circ}C$	600	1200	V
$I_{T(RMS)}$	RMS on-state current (full sine wave)	TO-220AB $T_c=100^{\circ}C$	-	20	A
		TO-220AB Ins $T_c=86^{\circ}C$	-		
I_{TSM}	Non-repetitive peak On-state current (full cycle, $T_J=25^{\circ}C$)	$F=50Hz, t=20ms$	-	200	A
		$F=60Hz, t=16.7ms$	-	210	A
I^2t	I^2t Value for fusing	$T_p=10ms$	-	200	A^2S
di/dt	Rate of rise of on-state current	$I_G=2 \times I_{GT}, t_r \leq 100ns, T_J=125^{\circ}C$	-	50	$A/\mu s$
I_{GM}	Peak gate current	$t_p=20\mu s, T_J=125^{\circ}C$	-	4	A
$P_{G(AV)}$	Average gate power		-	1	W
T_{STG}	Storage temperature		-40	150	$^{\circ}C$
T_J	Junction temperature		-40	125	$^{\circ}C$

BTA20/BTB20 Series
● Electrical Characteristics
■ 3 Quadrants

Symbol	Conditions	Quadrant		BTA20/BTB20			Unit
				SW	CW	BW	
I_{GT}	$V_D=12V, R_L=33\Omega$	I-II-III	MAX	10	35	50	mA
V_{GT}		I-II-III	MAX		1.3		V
V_{GD}	$V_D=V_{DRM}, R_L=3.3K\Omega, T_j=125^\circ C$	I-II-III	MIN		0.2		V
I_L	$I_T=1.2I_{GT}$	I-III	MAX	20	50	70	mA
		II	MAX	35	60	80	
I_H	$I_T=100mA$		MAX	15	40	60	mA
dv/dt	$V_{DM}=67\%V_{DRM}, \text{gate open}, T_j=125^\circ C$		MIN	40	400	1000	$V/\mu s$
	$(dv/dt)_c=0.1 V/\mu s, T_j=125^\circ C$			8.5	/	/	
$(di/dt)_c$	$(dv/dt)_c=10 V/\mu s, T_j=125^\circ C$		MIN	3.0	/	/	A/ms
	Without snubber, $T_j=125^\circ C$			/	8.5	14	

■ 4 Quadrants

Symbol	Conditions	Quadrant		BTA20/BTB20		Unit
				C	B	
I_{GT}	$V_D=12V, R_L=33\Omega$	I-II-III	MAX	25	50	mA
		IV		50	100	
V_{GT}		ALL	MAX		1.3	V
V_{GD}	$V_D=V_{DRM}, R_L=3.3K\Omega, T_j=125^\circ C$	ALL	MIN		0.2	V
I_L	$I_T=1.2I_{GT}$	I-III-IV	MAX	40	50	mA
		II	MAX	80	100	mA
I_H	$I_T=100mA$		MAX	25	50	mA
dv/dt	$V_{DM}=67\%V_{DRM}, \text{gate open}, T_j=125^\circ C$		MIN	200	400	$V/\mu s$
$(dv/dt)_c$	$(di/dt)_c=7A/ms, T_j=125^\circ C$		MIN	5	10	$V/\mu s$

BTA20/BTB20 Series
● Static Characteristics

Symbol	Conditions	Quadrant		Value	Unit
V_{TM}	$I_T=25A, t_p=380\mu s$	$T_J=25^\circ C$	MAX	1.55	V
I_{DRM}	$V_D=V_{DRM}, V_R=V_{RRM}$	$T_J=25^\circ C$	MAX	5	μA
I_{RRM}		$T_J=125^\circ C$	MAX	2	mA

● Thermal Characteristics

Symbol	Parameter	Value	Unit
$R_{th(j-mb)}$	Junction to Case(AC)	TO-220AB	1.2
		TO-220AB Insulated	2.1
$R_{th(j-a)}$	Junction to ambient	TO-220AB	60
		TO-220AB Insulated	

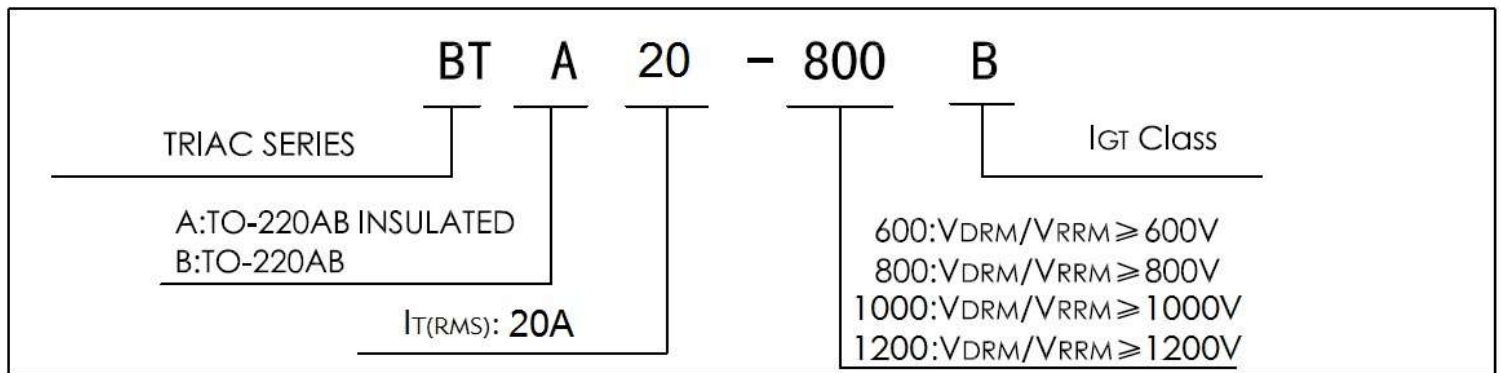
● Ordering Information

● Package Outline Dimensions

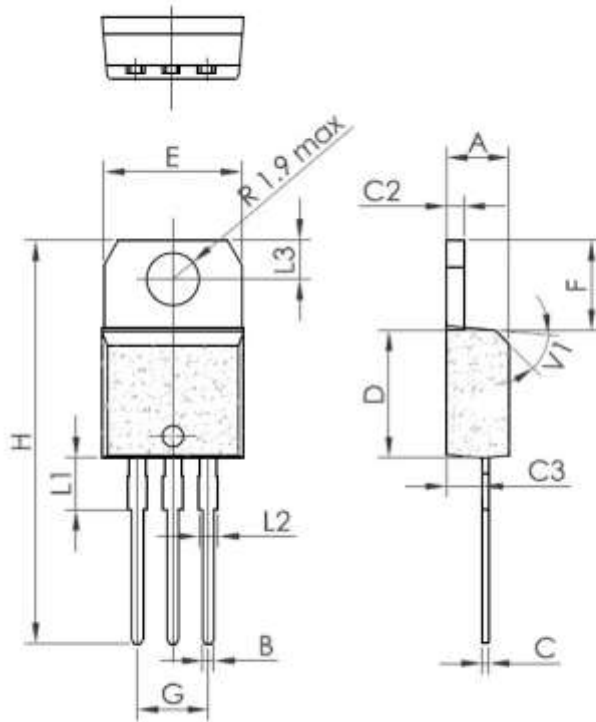
TO-220AB

Ref.	Dimensions					
	Millimeters			Inches		
	Min.	Typ.	Max.	Min.	Typ.	Max.
A	4.4		4.6	0.173		1.181
B	0.61		0.88	0.024		0.034
C	0.49		0.70	0.019		0.027
C2	1.23		1.32	0.048		0.051
C3	2.4		2.72	0.094		0.107
D	8.6		9.7	0.338		0.382
E	10		10.4	0.393		0.409
F	6.2		6.6	0.244		0.259
G	4.8		5.4	0.189		0.213
H	28.0		29.8	11.0		11.7
L1		3.75			0.147	
L2	1.14		1.7	0.044		0.066
L3	2.65		2.95	0.104		0.116
V1		40°			40°	

FIG.1 Maximum power dissipation versus RMS on-state current

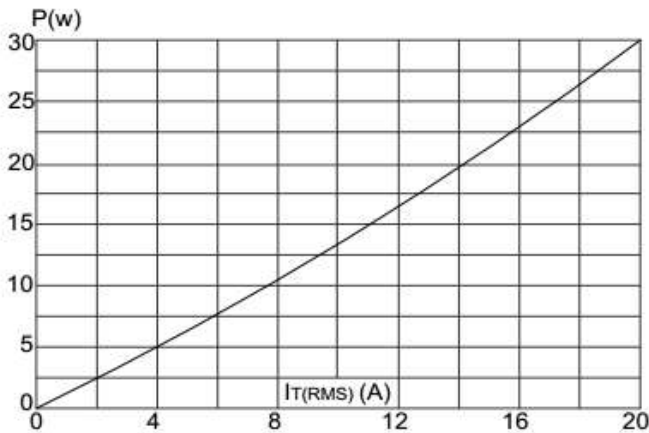

FIG.2: RMS on-state current versus case temperature

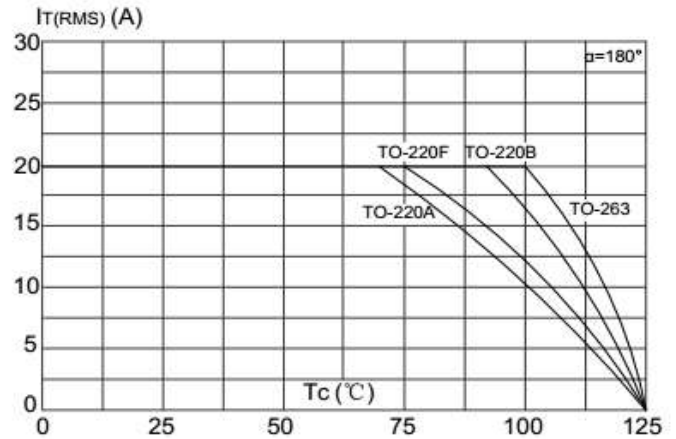

FIG.3: Surge peak on-state current versus number of cycles

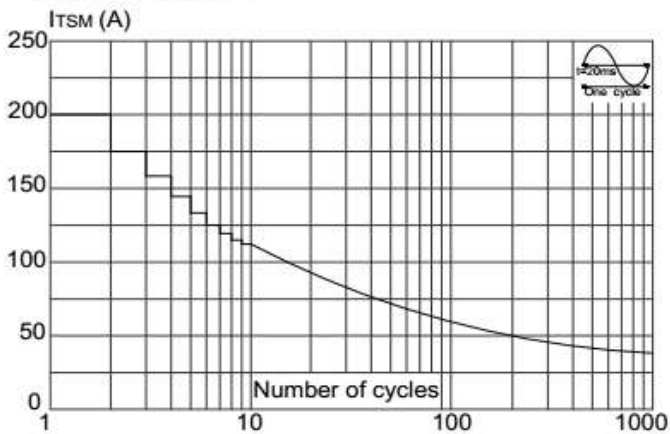

FIG.4: On-state characteristics (maximum values)

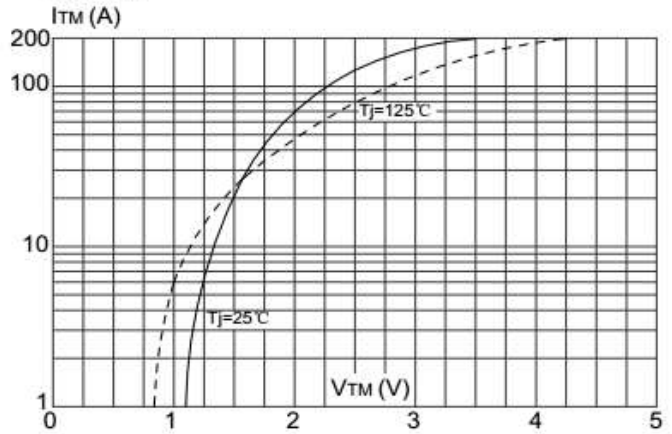

FIG.5: Non-repetitive surge peak on-state current for a sinusoidal pulse with width $t_p < 20ms$, and corresponding value of I^2t ($di/dt < 100A/\mu s$)

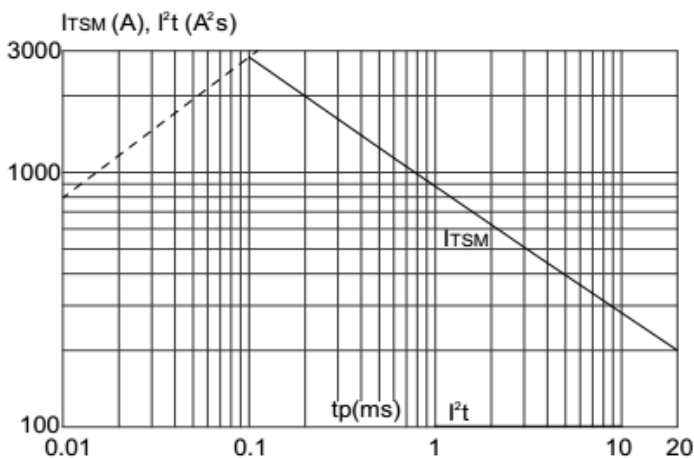

FIG.6: Relative variations of gate trigger current, holding current and latching current versus junction temperature

