

# FR151 – FR157

## 1.5A FAST RECOVERY RECTIFIER

### Features

- Diffused Junction
- Low Forward Voltage Drop
- High Current Capability
- High Reliability
- High Surge Current Capability

### Mechanical Data

- Case: Molded Plastic
- Terminals: Plated Leads Solderable per MIL-STD-202, Method 208
- Polarity: Cathode Band
- Weight: 0.40 grams (approx.)
- Mounting Position: Any
- Marking: Type Number

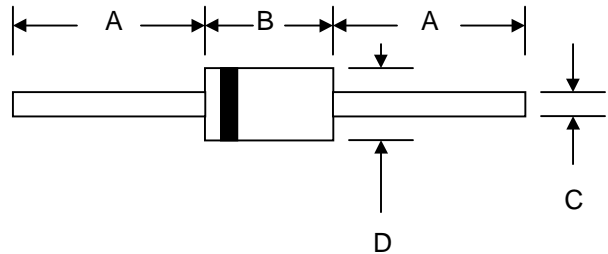

DO-15		
Dim	Min	Max
A	25.4	—
B	5.50	7.62
C	0.71	0.864
D	2.60	3.60
All Dimensions in mm		

### Maximum Ratings and Electrical Characteristics @ $T_A=25^\circ\text{C}$ unless otherwise specified

Single Phase, half wave, 60Hz, resistive or inductive load.  
 For capacitive load, derate current by 20%.

Characteristic	Symbol	FR151	FR152	FR153	FR154	FR155	FR156	FR157	Unit
Peak Repetitive Reverse Voltage	$V_{RRM}$								V
Working Peak Reverse Voltage	$V_{RWM}$	50	100	200	400	600	800	1000	
DC Blocking Voltage	$V_R$								
RMS Reverse Voltage	$V_{R(RMS)}$	35	70	140	280	420	560	700	V
Average Rectified Output Current (Note 1)	$I_O$	1.5							A
Non-Repetitive Peak Forward Surge Current 8.3ms Single half sine-wave superimposed on rated load (JEDEC Method)	$I_{FSM}$	60							A
Forward Voltage @ $I_F = 1.5\text{A}$	$V_{FM}$	1.2							V
Peak Reverse Current @ $T_A = 25^\circ\text{C}$ At Rated DC Blocking Voltage @ $T_A = 100^\circ\text{C}$	$I_{RM}$	5.0 100							$\mu\text{A}$
Reverse Recovery Time (Note 2)	$t_{rr}$	150				250	500		nS
Typical Junction Capacitance (Note 3)	$C_j$	30							pF
Operating Temperature Range	$T_j$	-65 to +125							$^\circ\text{C}$
Storage Temperature Range	$T_{STG}$	-65 to +150							$^\circ\text{C}$

**\*Glass passivated forms are available upon request**

- Note: 1. Leads maintained at ambient temperature at a distance of 9.5mm from the case  
 2. Measured with  $I_F = 0.5\text{A}$ ,  $I_R = 1.0\text{A}$ ,  $IRR = 0.25\text{A}$ . See figure 5.  
 3. Measured at 1.0 MHz and applied reverse voltage of 4.0V D.C.

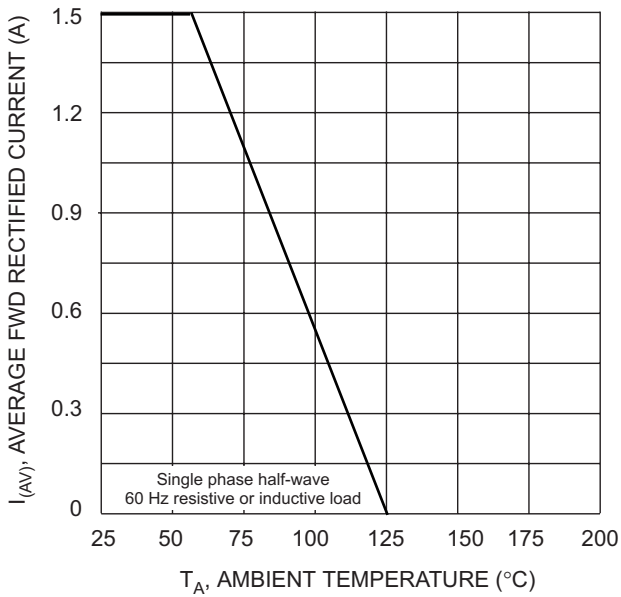

Fig. 1 Forward Derating Curve

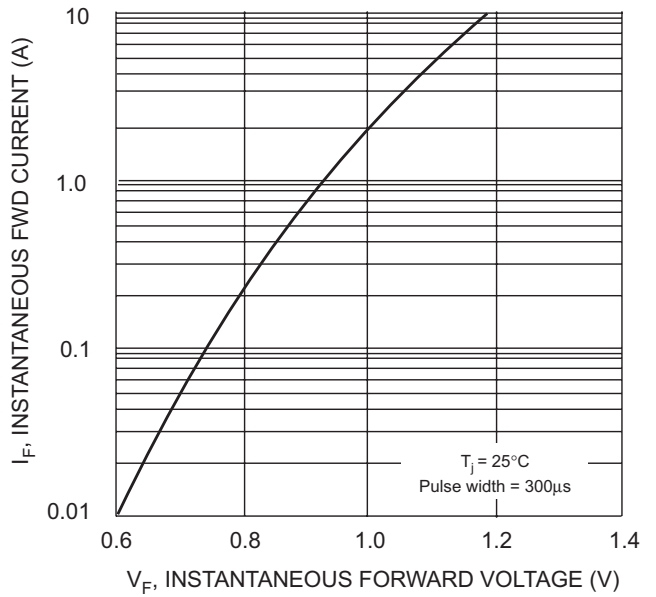

Fig. 2 Typical Forward Characteristics

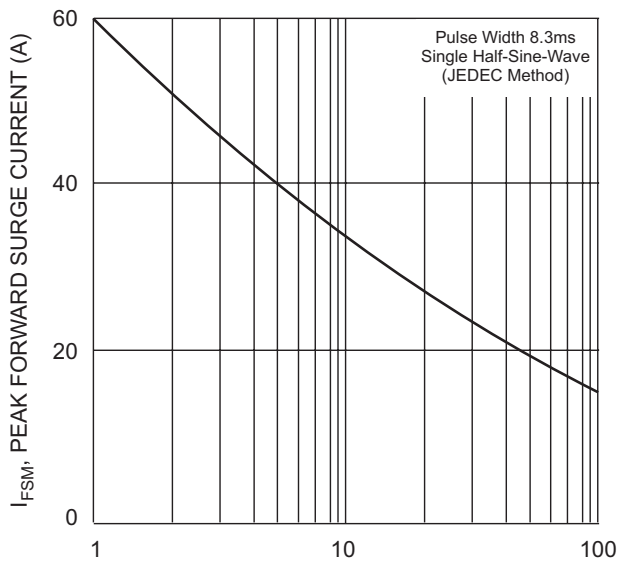

Fig. 3 Peak Forward Surge Current

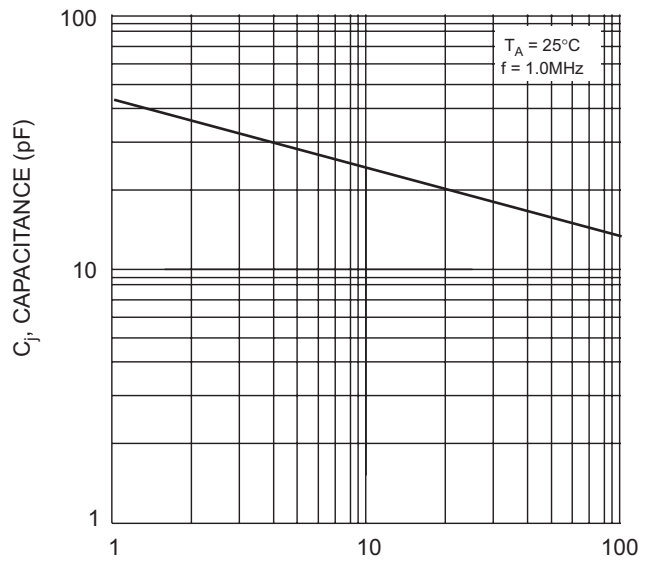
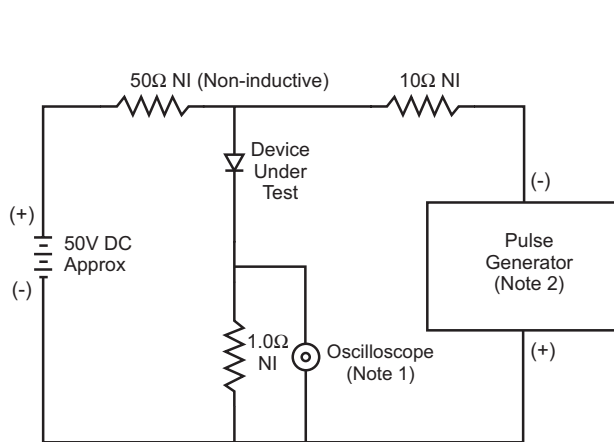
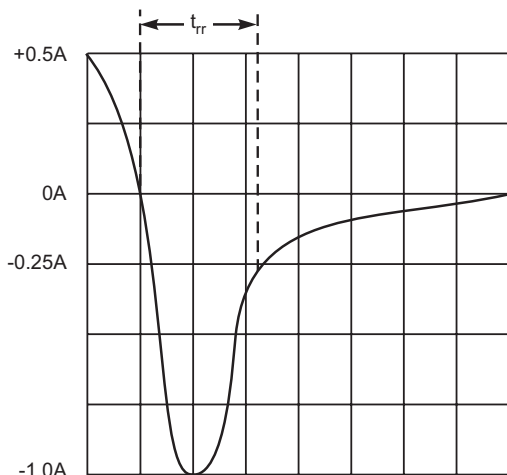

Fig. 4 Typical Junction Capacitance



- Notes:
1. Rise Time = 7.0ns max. Input Impedance = 1.0MΩ, 22pF.
  2. Rise Time = 10ns max. Input Impedance = 50Ω.



Set time base for 5/10ns/cm

Fig. 5 Reverse Recovery Time Characteristic and Test Circuit

## ORDERING INFORMATION

Product No.◆	Package Type	Shipping Quantity
FR151-T3	DO-15	4000/Tape & Reel
<b>FR151-TB</b>	DO-15	3000/Tape & Box
FR151	DO-15	1000 Units/Box
FR152-T3	DO-15	4000/Tape & Reel
<b>FR152-TB</b>	DO-15	3000/Tape & Box
FR152	DO-15	1000 Units/Box
FR153-T3	DO-15	4000/Tape & Reel
<b>FR153-TB</b>	DO-15	3000/Tape & Box
FR153	DO-15	1000 Units/Box
FR154-T3	DO-15	4000/Tape & Reel
<b>FR154-TB</b>	DO-15	3000/Tape & Box
FR154	DO-15	1000 Units/Box
FR155-T3	DO-15	4000/Tape & Reel
<b>FR155-TB</b>	DO-15	3000/Tape & Box
FR155	DO-15	1000 Units/Box
FR156-T3	DO-15	4000/Tape & Reel
<b>FR156-TB</b>	DO-15	3000/Tape & Box
FR156	DO-15	1000 Units/Box
FR157-T3	DO-15	4000/Tape & Reel
<b>FR157-TB</b>	DO-15	3000/Tape & Box
FR157	DO-15	1000 Units/Box

Products listed in **bold** are WTE **Preferred** devices.

◆T3 suffix refers to a 13" reel. TB suffix refers to Ammo Pack.

Shipping quantity given is for minimum packing quantity only. For minimum order quantity, please consult the Sales Department.

Won-Top Electronics Co., Ltd (WTE) has checked all information carefully and believes it to be correct and accurate. However, WTE cannot assume any responsibility for inaccuracies. Furthermore, this information does not give the purchaser of semiconductor devices any license under patent rights to manufacturer. WTE reserves the right to change any or all information herein without further notice.

**WARNING:** DO NOT USE IN LIFE SUPPORT EQUIPMENT. WTE power semiconductor products are not authorized for use as critical components in life support devices or systems without the express written approval.

**Won-Top Electronics Co., Ltd.**

No. 44 Yu Kang North 3rd Road, Chine Chen Dist., Kaohsiung, Taiwan

**Phone:** 886-7-822-5408 or 886-7-822-5410

**Fax:** 886-7-822-5417

**Email:** sales@wontop.com

**Internet:** http://www.wontop.com

*We power your everyday.*