

SANYO

No.2087C

LA4557

2-CHANNEL AF POWER AMP. FOR RADIO,
TAPE RECORDER USE**Features**

- . Low quiescent current
- . On-chip 2 channels permitting use in stereo and bridge amplifier applications.
- . High output
- . Minimum number of external parts required (9 pos. minimum)
- . Good ripple rejection (55dB)
- . Soft tone at the output saturation mode
- . Good channel separation
- . Easy thermal design
- . Small pop noise at the time of power supply ON/OFF
- . On-chip muting

Maximum Ratings at Ta=25°C

			unit
Maximum Supply Voltage	V_{CCmax}	Quiescent	15 V
		Operating	12 V
Allowable Power Dissipation	$Pdmax$	With recommended PCB	4 W
Operating Temperature	$Topr$		-20 to +75 °C
Storage Temperature	$Tstg$		-55 to +150 °C

Operating Conditions at Ta=25°C

			unit
Recommended Supply Voltage	V_{CC}		7.5 to 9.0 V
Load Resistance	R_L	Stereo	3 to 8 ohm
		BTL	8 ohm
Operating Voltage Range	V_{CCop}		4.5 to 12 V

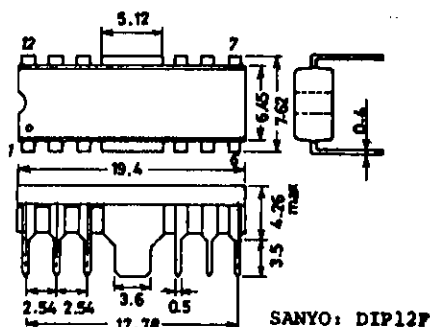
Package Dimensions 3022A-D12FIC
(unit: mm)

Operating Characteristics at $T_a=25^{\circ}\text{C}$, $V_{CC}=9\text{V}$, $f=1\text{kHz}$, $R_g=600\text{ohms}$, $R_L=4\text{ohms}$, $V_G=50\text{dB}$,
See specified Test Circuit.

			min	typ	max	unit
Quiescent Current	I_{CCO}	$R_g=0$		20	40	mA
Voltage Gain	V_G	$V_{IN}=-50\text{dBm}$	48	50	52	dB
Voltage Gain Difference	ΔV_G	$V_{IN}=-50\text{dBm}$			± 1	dB
Output Power	P_o	THD=10%, stereo	1.7	2.4		W
		THD=10%, BTL ($R_L=8\text{ohms}$)		4.5		W
Total Harmonic Distortion	THD	$P_o=250\text{mW}$		0.3	1.0	%
Input Resistance	r_i		21	30		kohm
Output Noise Voltage	V_{NO}	$R_g=0$, stereo		0.5	1.0	mV
		$R_g=10\text{kohms}$, stereo		0.8	2.0	mV
Ripple Rejection	R_r	$R_g=0$, $f_R=100\text{Hz}$, $V_{CCR}=0\text{dBm}$	45	55		dB
Crosstalk	CT	$R_g=10\text{kohms}$, $V_o=0\text{dBm}$	45	55		dB
Muting Attenuation	A_{TT}	$V_o=0\text{dBm}$, $\text{pin}1=9\text{V}$	70			dB

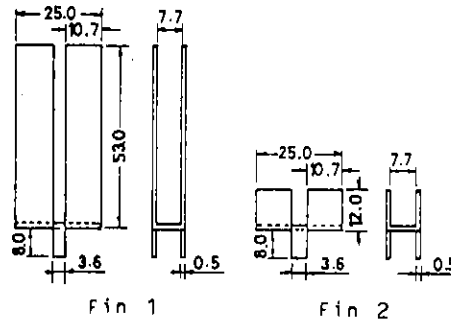
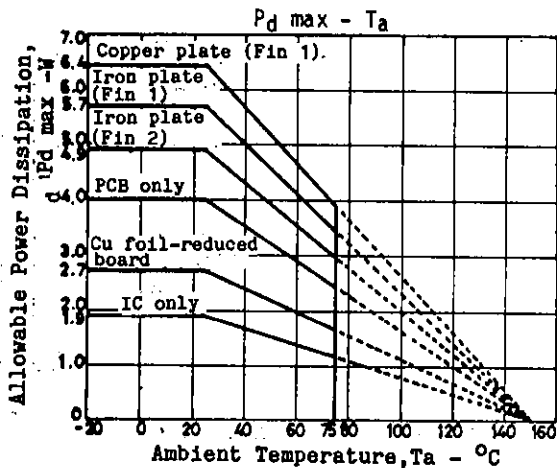

Equivalent Circuit Block Diagram

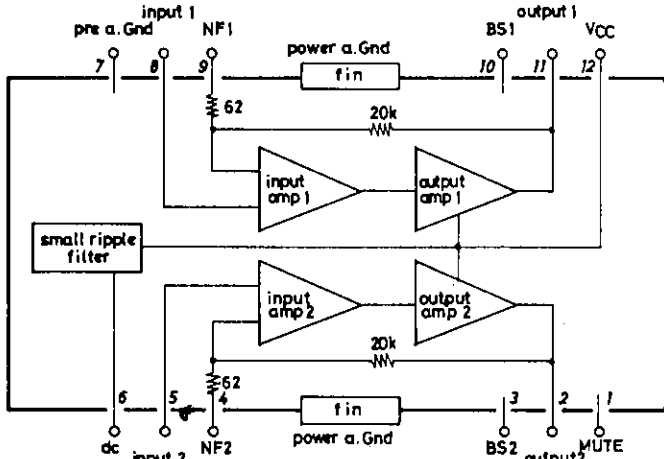

Unit (resistance: Ω , capacitance: F)

Sample Application Circuit: Stereo Use

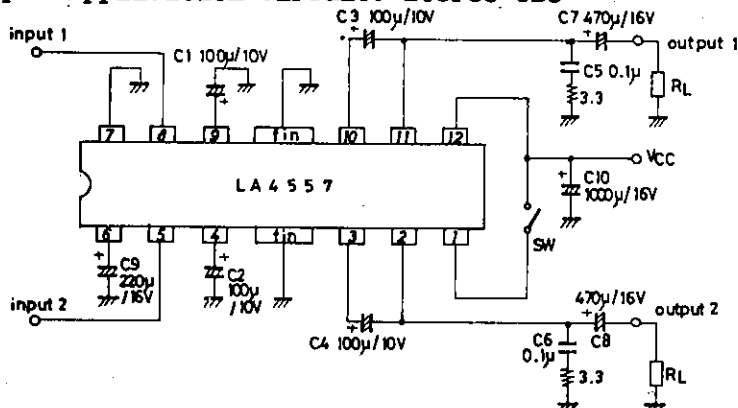

Sample Printed Circuit Pattern (Cu-foiled side)

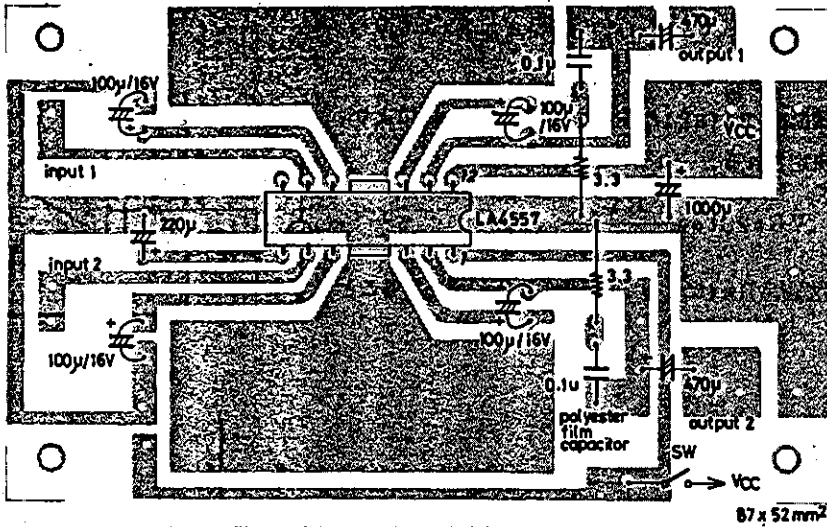

Sample Application Circuit: Bridge Amp Use

Unit (resistance: Ω, capacitance: F)

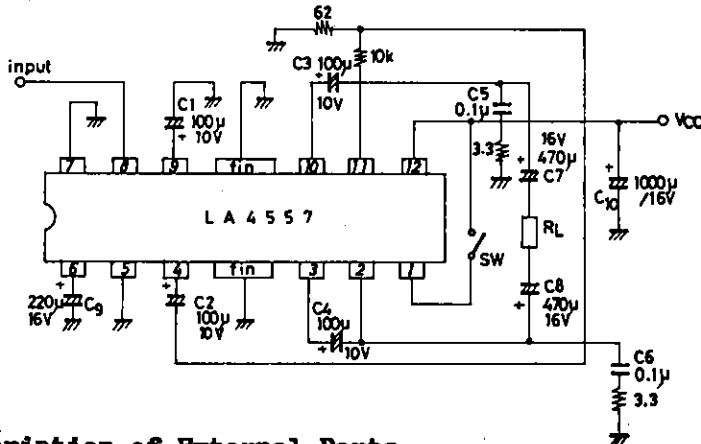

Description of External Parts

C1(C2): Feedback capacitor. The low cutoff frequency is determined by the following formula.

$$f_L = \frac{1}{2\pi C1Rf}$$

f_L : Low cutoff frequency
 R_f : Feedback resistor

Since this capacitor as well as decoupling capacitor affects the starting time, the capacitor value must be fixed with the necessary low frequency band fully considered.

C3(C4): Bootstrap capacitor. The output at low frequencies depends on this capacitor. Decreasing the capacitor value lowers the output at low frequencies. A capacitor value of 47µF or more is required.

C5(C6): Oscillation blocking capacitor. Use a polyester film capacitor that is good in high frequency response and temperature characteristic. The use of an electrolytic capacitor, ceramic capacitor may cause oscillation to occur at low temperatures.

C7(C8): Output capacitor. The low cutoff frequency is determined by the following formula.

$$f_L = \frac{1}{2\pi C7R_L}$$

f_L : Low cutoff frequency
 R_L : Load resistance

To make the low frequency response in the bridge amplifier mode identical with that in the stereo mode, the capacitor value must be doubled.

- C9: Decoupling capacitor. Used for the ripple filter. Since the rejection effect is saturated at a certain capacitor value, it is meaningless to increase the capacitor values more than needed. This capacitor, being also used for the time constant of the muting circuit, affects the starting time.
- C10: Power source capacitor

Application Circuits

Voltage gain adjust

. Stereo mode

The voltage gain is determined by on-chip resistor R1(R2) and external feedback resistor R_{NF} as follows:

$$VG = 20 \log \frac{R1}{R_{NF} + R2} \text{ [dB]}$$

Any voltage gain can be obtained by external resistor R_{NF} .

. Bridge amplifier mode

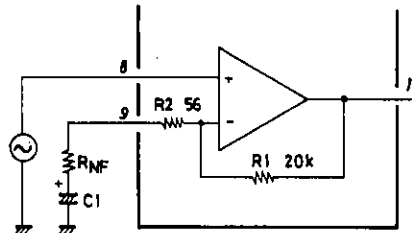
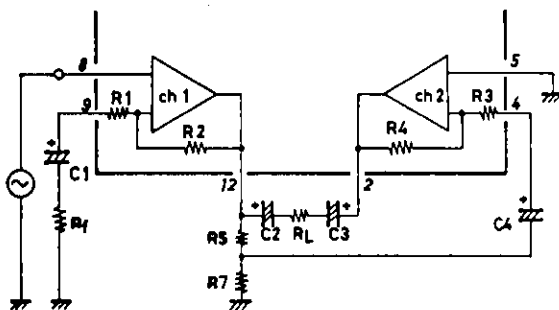

Unit (resistance: Ω)

The CH1 is a noninverting amplifier and the CH2 is an inverting amplifier. The total voltage gain, being apparently higher than that of the CH1 by 6dB, is approximately calculated by the following formula.

$$VG = 20 \log \frac{R2}{R1} + 6 \text{ (dB)}$$

To reduce the voltage gain, R_f is connected and the following formula is used.

$$VG = 20 \log \frac{R2}{R_f + R1} + 6 \text{ (dB)}$$

Proper cares in using LA4557-applied set

1. Slider contact noise of variable resistor

Since the input circuit uses PNP transistors, no input coupling capacitor is required. However, if slider contact noise of the variable resistor presents any problem, connect a capacitor in series with input.

2. Pop noise

If pop noise generated at the time of power ON/OFF disturbs you, connect a resistor of 500ohms to 1kohm across the middle point and GND.

Thermal design

Since the DIP12F package is such that the Cu-foiled area of the printed circuit board is used to dissipate heat, make the Cu-foiled area in the vicinity of the heat sink of the IC as large as possible when designing the printed circuit board. Power dissipation P_d is increased depending on the supply voltage and load. So, it is recommended to use the printed circuit board together with the heat sink. The following is a formula to be used to calculate P_d (for stereo use). For AC power supply, however, it is recommended to actually measure P_d on the transformer of each set. For bridge amplifier use, P_d is calculated at 1/2 of the load.

(1) DC power supply

$$P_{d \max} = \frac{V_{CC}^2}{\pi^2 R_L} + I_{CC0} \cdot V_{CC} \text{ (for stereo use) } \dots (1)$$

(2) AC power supply

V_{CC2} : Supply voltage at quiescent mode

$V_{CC(Pd)}$: Supply voltage at $P_d \max$

V_{CC1} : Supply voltage at maximum output

r : Voltage regulation $\frac{V_{CC2} - V_{CC1}}{V_{CC1}}$

I_{CC0} : Quiescent current

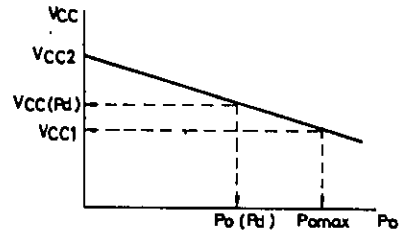

Line regulation

$$P_{d \max} = \frac{V_{CC(Pd)}^2}{\pi^2 R_L} + I_{CC0} \cdot V_{CC(Pd)} \text{ (for stereo use) } \dots (2)$$

where

$$V_{CC(Pd)} = \frac{(1+r)V_{CC1}}{1 + \frac{r - V_{CC1}}{\sqrt{2} \cdot \pi \cdot R_L} \times \sqrt{P_{o \max}}}$$

Example of Heat Sink Mounting Method

The heat sink must be of such a shape as to be able to dissipate heat from the IC plastic area and fin area and is soldered to the printed circuit board as shown below. For the size of the heat sink, refer to the P_d - T_a characteristic. The material of the heat sink is recommended to be copper or iron which is solderable. It is recommended to apply silicone grease to the IC plastic area to reduce thermal resistance between the heat sink and the IC plastic area.

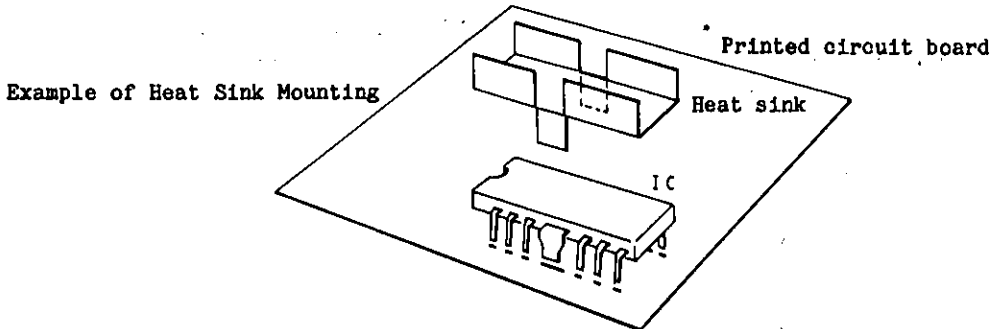

Proper Cares in Using IC

1. If the IC is used in the vicinity of the maximum ratings, even a slight variation in conditions may cause the maximum ratings to be exceeded, thereby leading to breakdown. Allow an ample margin of variation for supply voltage, etc. and use the IC in the range where the maximum ratings are not exceeded.
2. Pin-to-pin short: If power is applied when the space between pins is shorted, breakdown or deterioration may occur. When mounting the IC on the board or applying power, make sure that the space between pins is not shorted with solder, etc.
3. Load short: If the IC is used with the load shorted for a long time, breakdown or deterioration may occur. Be sure not to short the load.
4. When the IC is used in radios or radio cassette tape recorders, keep a good distance between IC and bar antenna.
5. When making the board, refer to the sample printed circuit pattern.
6. It should be noted that some plug jacks to be used for connecting to the external speaker are such that both poles are shorted once when connecting.

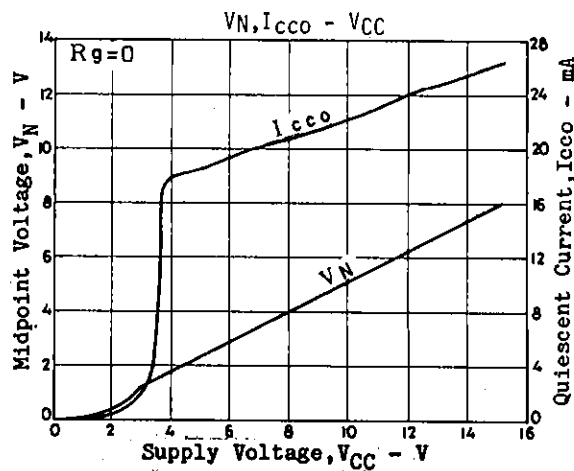
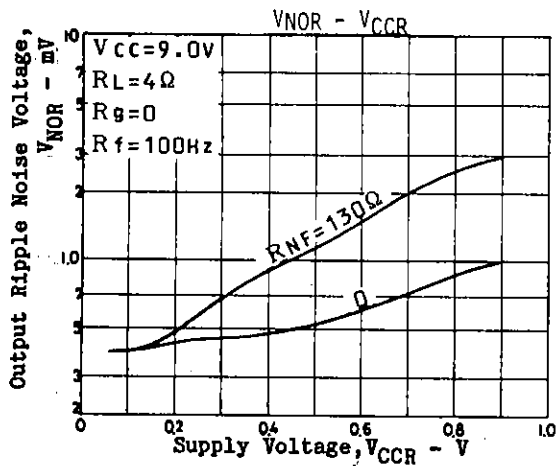
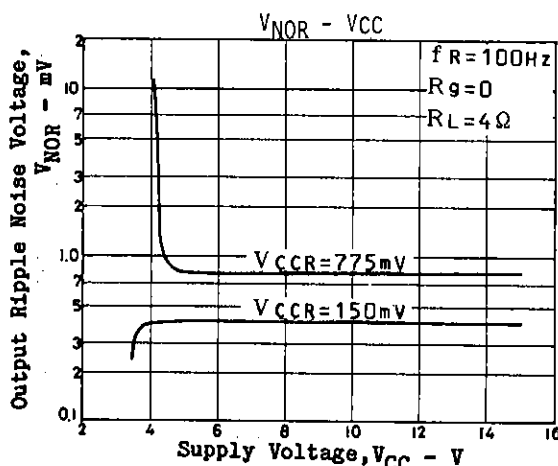
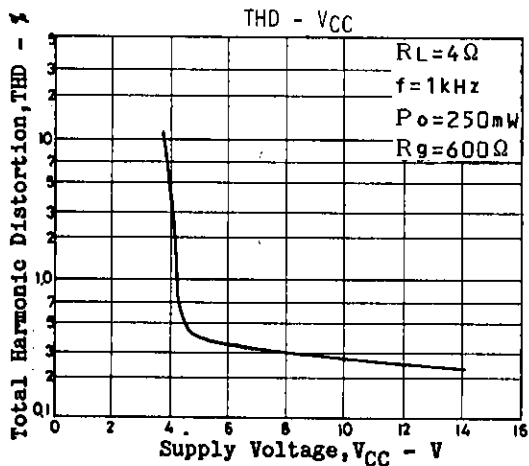
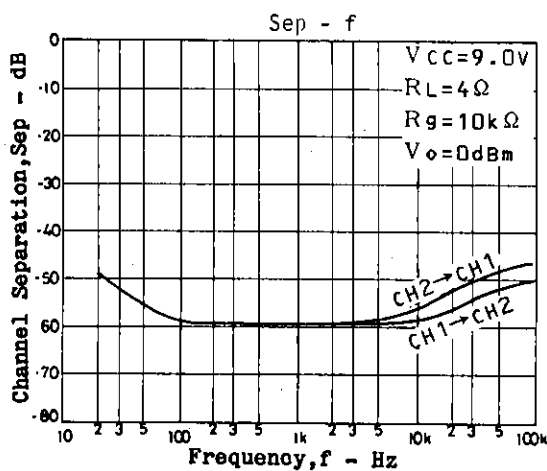
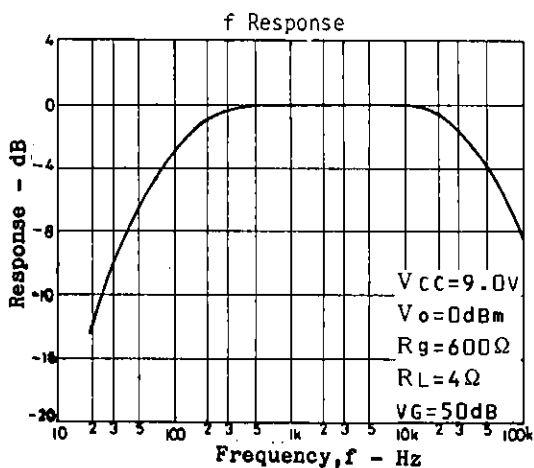
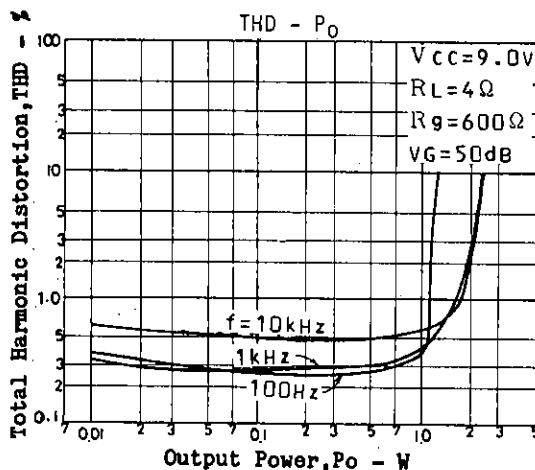
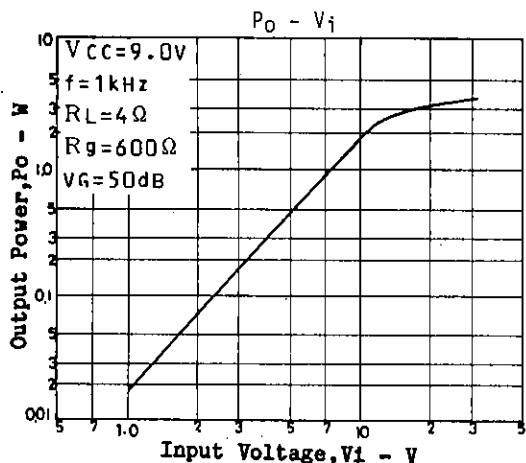

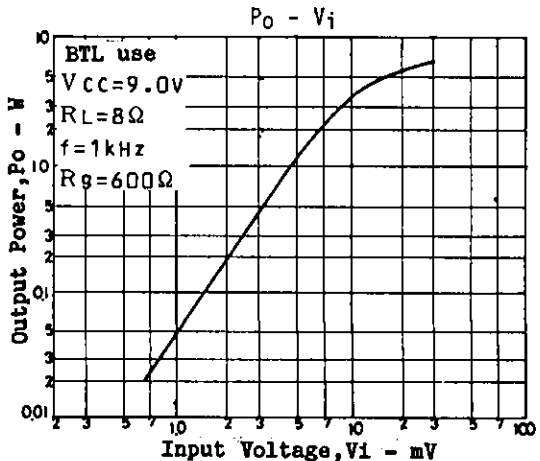
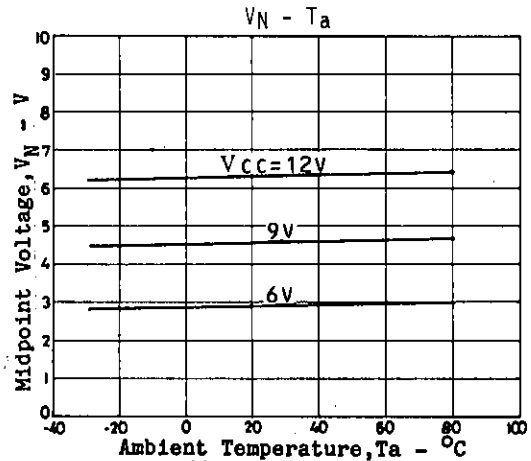
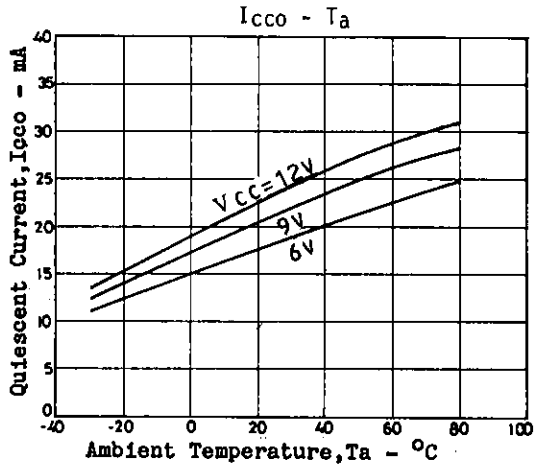
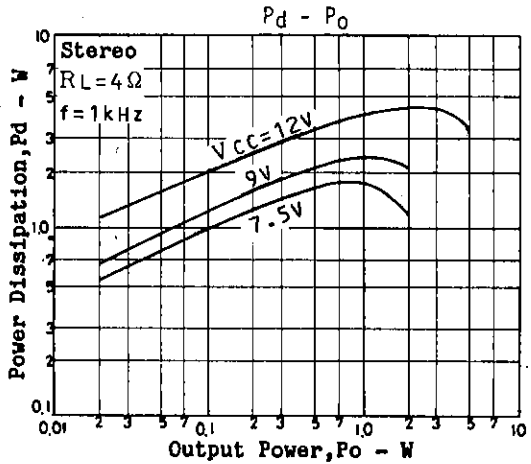
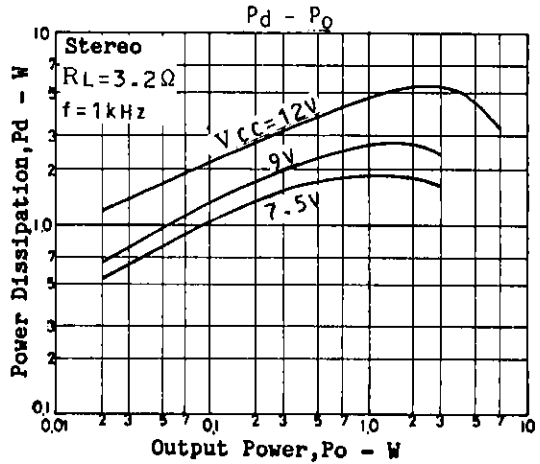
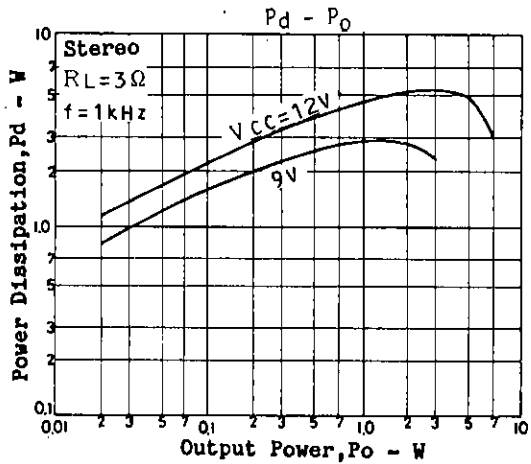
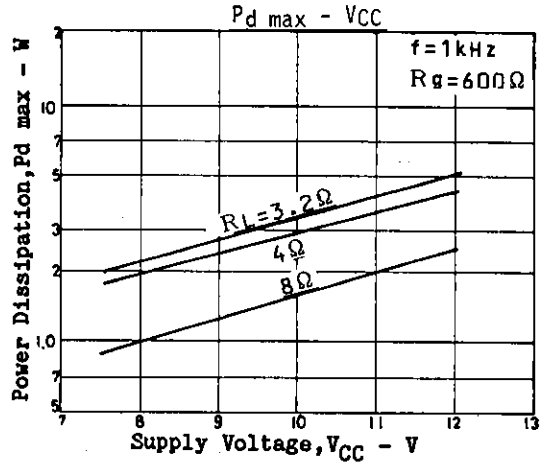
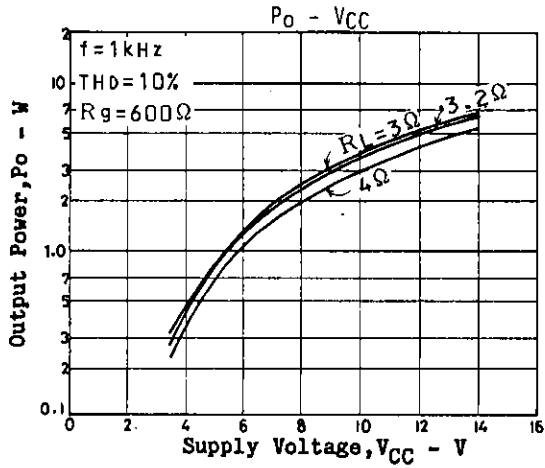

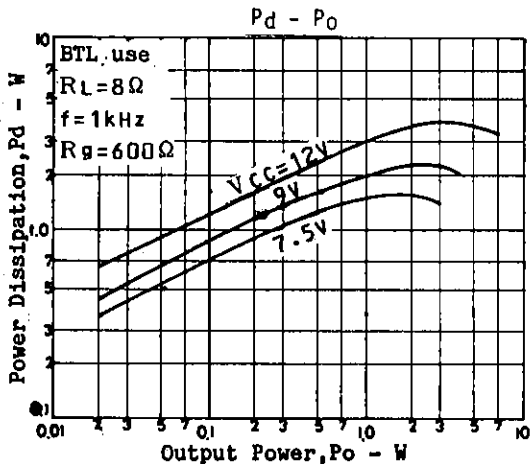
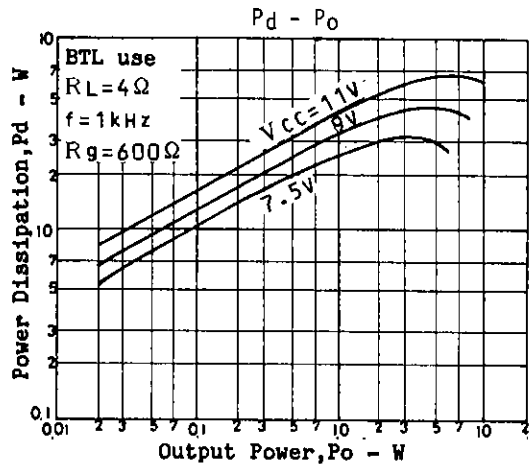
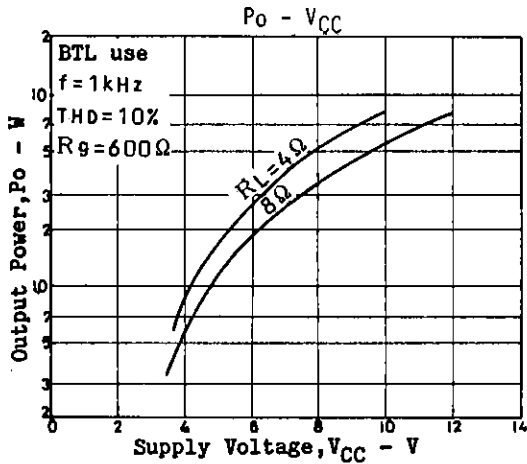
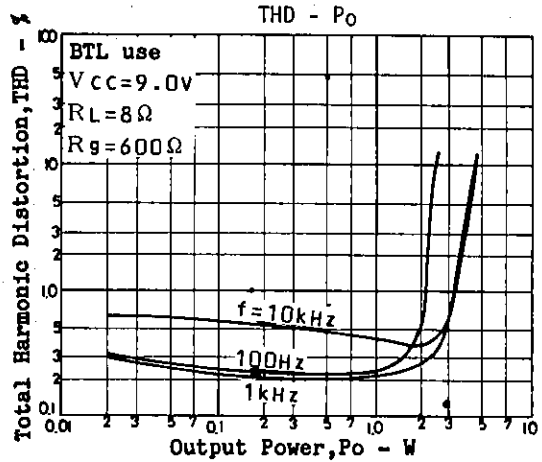
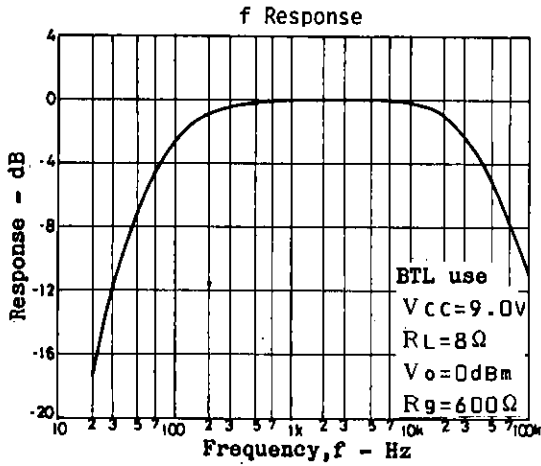

- No products described or contained herein are intended for use in surgical implants, life-support systems, aerospace equipment, nuclear power control systems, vehicles, disaster/crime-prevention equipment and the like, the failure of which may directly or indirectly cause injury, death or property loss.
- Anyone purchasing any products described or contained herein for an above-mentioned use shall:
 - ① Accept full responsibility and indemnify and defend SANYO ELECTRIC CO., LTD., its affiliates, subsidiaries and distributors and all their officers and employees, jointly and severally, against any and all claims and litigation and all damages, cost and expenses associated with such use;
 - ② Not impose any responsibility for any fault or negligence which may be cited in any such claim or litigation on SANYO ELECTRIC CO., LTD., its affiliates, subsidiaries and distributors or any of their officers and employees jointly or severally.
- Information (including circuit diagrams and circuit parameters) herein is for example only; it is not guaranteed for volume production. SANYO believes information herein is accurate and reliable, but no guarantees are made or implied regarding its use or any infringements of intellectual property rights or other rights of third parties.